

# REVITIVE®

OXYWAVE®  
TECHNOLOGY

## Medic User's Manual



**Drug-Free  
Clinically Proven  
Certified Medical Device**



**Please read the  
User's Manual carefully  
before using this product**

**USE ONLY AS DIRECTED**

If symptoms persist, consult  
your healthcare professional





5573AQ

**CIRCULATION BOOSTER®**

### For best results

Use daily

 Intensity **40+**

 **30-60** min

 for **60+** days

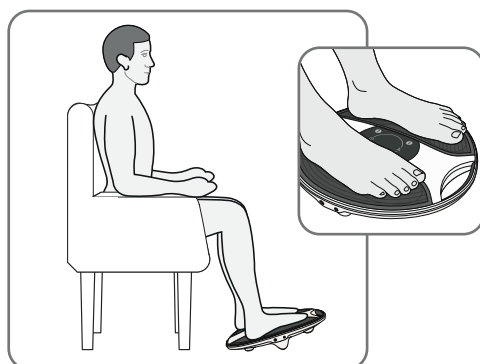

### How-to videos

For videos of setup and using your Revitive system, go to:

**support.revitive.com**

### 2-year warranty

To activate your free 2-year warranty please register your device at:

**support.revitive.com**

## Table of contents

<b>What's in the box?</b>	<b>4</b>
<b>Parts and Controls</b>	<b>5-6</b>
<b>Introduction to Revitive</b>	<b>7-8</b>
Operator profile	7
Indications for use	7-8
<b>Important Safeguards</b>	<b>9-14</b>
Who should <b>NOT</b> use Revitive	9
Warnings and Cautions	10-12
Safety precautions	12
Adverse reactions	14
<b>Instructions for use</b>	<b>15-28</b>
Step 1: Setting up Revitive for the first time	15
Step 2: Powering Revitive	16-17
Step 3: Using the SoftTouch foot-pads	18-21
Step 4: Using the dual mode small electrode pads	22-27
4.1: Switching between EMS and TENS mode	27
Step 5: Cleaning and storing	28
Replacing the batteries & small electrode pads	28
<b>Troubleshooting</b>	<b>29-31</b>
<b>Technical Specifications</b>	<b>32-34</b>
<b>Warranty</b>	<b>35</b>

# What's in the box? \_\_\_\_\_

On opening the carton, please check that the following components are provided. If you think anything is missing, please contact us using the helpline numbers on the back of this booklet.

- 1** Power adapter  
Cable length 180cm

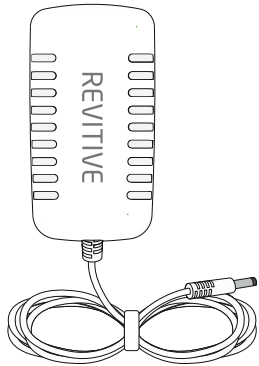

- 3** Small electrode pads (2044)

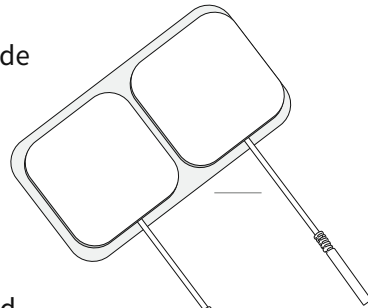

- 4** Electrode cord  
Cable length 150cm

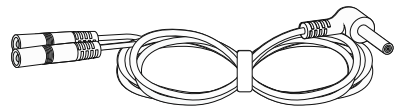

- 2** Revitive Medic



- 5** Remote control

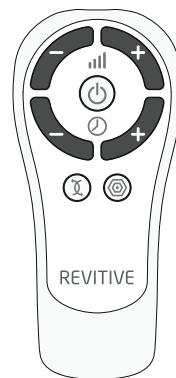

- 6** AAA batteries x 2

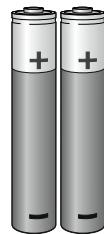

# Parts and controls \_\_\_\_\_

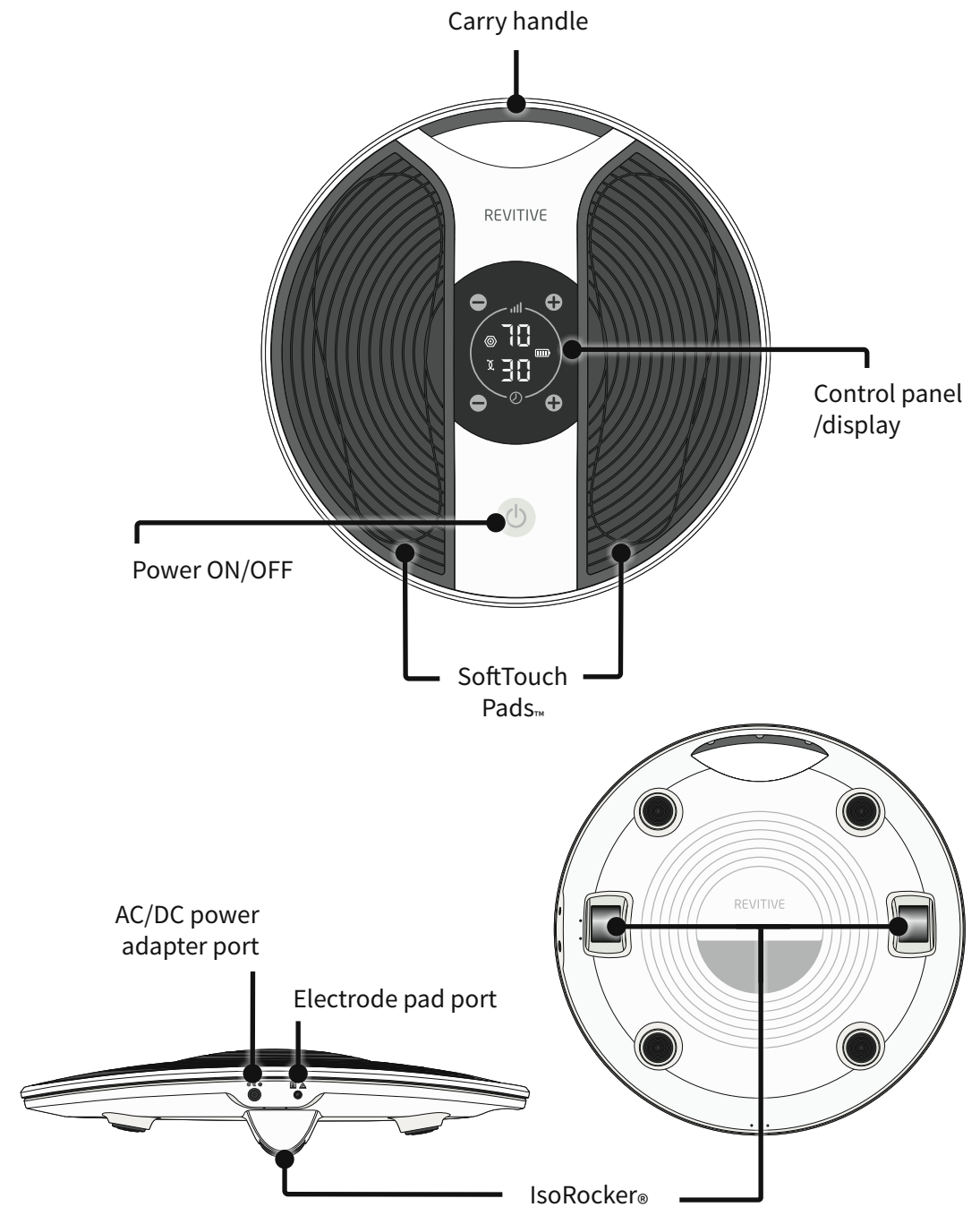

# Parts and controls

## Control panel

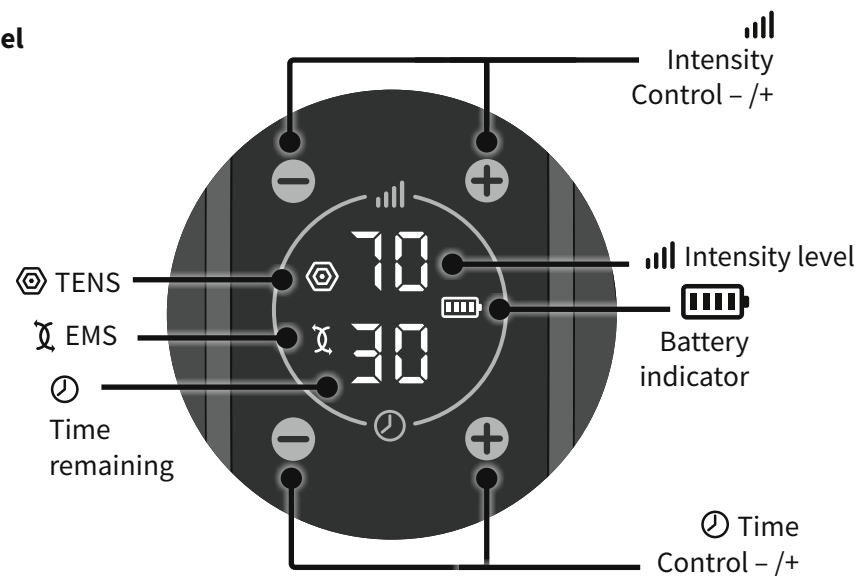

## Remote control

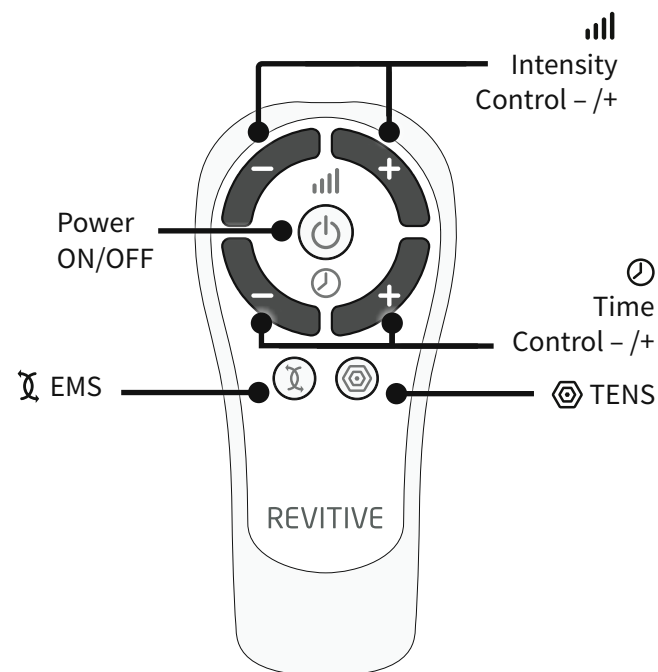

# Introduction to Revitive

## Operator Profile

The intended operator profile is based on users in the home environment who may suffer from immobility, osteoarthritis of the knee, poor circulation and related issues such as pain, leg stiffness and swelling in the legs, ankles and feet. It is also suitable for rehabilitation following knee-surgery.

Revitive is intended for use by the end user in a non-clinical setting and without the supervision or intervention of a clinician during use.

A typical user may be of any adult age range and is not specific to any demographic of gender, ethnicity or educational background.

## Electrical Muscle Stimulation (EMS) Indications for use

### When using the foot-pads, Revitive is intended to:

- Reduce pain and discomfort in the legs/ankles/feet - caused by poor circulation (Peripheral Arterial Disease).
- Improve circulation in the legs - caused by Peripheral Arterial Disease.
- Improve circulation to reduce or prevent blood-pooling (stasis) - caused by poor circulation (Chronic Venous Insufficiency/varicose veins).
- Increase walking distance before the onset of claudication symptoms (pain) - caused by Peripheral Arterial Disease.
- Improve symptoms associated with varicose veins/ Chronic Venous Insufficiency.
- Help maintain leg vein health - by increasing circulation, delivering more oxygenated-blood and reducing swelling (oedema) in the legs, feet & ankles.

### When using electrode pads, applied to the legs, Revitive is intended to:

- Reduce pain and discomfort in the legs/ankles/feet - caused by Diabetic Peripheral Neuropathy, or swelling (oedema) due to osteoarthritis or following surgery
- Reduce swelling in the legs/ankles/feet - caused by being immobile due to osteoarthritis or an injury.

## Introduction to Revitive

### Electrical Muscle Stimulation (EMS) Indications for use continued

#### When using electrode pads, applied to the legs, Revitive is intended to:

- Improve circulation to reduce or prevent blood-pooling (stasis) - caused by diabetes or by being immobile following surgery.
- Increase muscle strength to help regain mobility in the legs affected by being immobile due to COPD, osteoarthritis or following surgery.

If you are otherwise healthy and have a sedentary lifestyle or spend long periods inactive, Revitive may help to:

- Alleviate tired, aching & heavy legs, including cramp
- Reduce swollen feet & ankles
- Help maintain leg vein health
- Strengthen leg muscles
- Actively increase circulation

### Transcutaneous Electrical Nerve Stimulation (TENS) Indications for use

#### When using electrode pads, Revitive is intended to provide:

- Temporary relief of pain of musculoskeletal or neuropathic origin
- Relief of arthritis-associated pain
- Relief and management of chronic pain, associated with musculoskeletal pain, osteoarthritis and fibromyalgia
- Relief of post-surgical and post-traumatic pain

The above Indications for Use are certified under the Medical Devices Directive 93/42/EEC.

## Important safeguards

**Read all instructions before use.**

**Save these instructions.**

**Revitive should not be used by some people.**



### Do not use if (contraindications):

- You are fitted with an electronic implanted device such as a heart pacemaker or Automatic Implantable Cardioverter Defibrillator (AICD)
- You are pregnant
- You are being treated for, or have the symptoms of, an existing Deep Vein Thrombosis (“DVT”)

Long periods of inactivity can put you at greater risk of developing Deep Vein Thrombosis (DVT). DVT is a blood clot and usually occurs in a deep leg vein. If part of the DVT breaks off it may lead to potentially life-threatening complications such as pulmonary embolism.

If you have been inactive for prolonged periods and suspect you may have a DVT, consult your doctor immediately. **To prevent dislodging the clot do not use Revitive.**

In some cases of DVT there may be no symptoms. However it is important to be aware of the symptoms that may include:

- Pain, swelling and tenderness in one of your legs (usually your calf)
- A heavy ache in the affected area
- Warm skin in the area of the clot
- Redness of your skin, particularly at the back of your leg, below the knee

Consult your doctor as soon as possible if you show any signs of the above symptoms.

# Important safeguards

## Warnings

### Consult with your doctor before using this device if:

- You are in the care of a doctor
- You have a history of heart problems
- You have had medical or physical treatment for your pain
- You have suspected or diagnosed heart disease
- You have suspected or diagnosed epilepsy
- You are unsure about the suitability of the device for you
- You are unsure about the cause of your symptoms

### If you have a metallic implant:

- If you have a metallic implant, you may experience pain or discomfort near the implant when applying electrical stimulation. If this should occur discontinue use and seek advice from your doctor
- The electrical stimulation may feel more intense close to a metallic implant. It is safe to continue use provided no pain is experienced. You may need to adjust the intensity to a comfortable level

### When applying foot-pads or electrode pads:

- Do **not** use the electrode pads on your head, face, neck or chest
- Application of the electrodes near the thorax (chest) may increase the risk of cardiac fibrillation
- Only apply to areas with intact/unbroken skin
- Do not apply foot-pads or electrode pads directly or adjacent to these areas:
  - on cut or broken skin, open wounds or rashes; swollen, red, infected or inflamed areas; or skin eruptions (such as phlebitis, thrombophlebitis, varicose veins, cellulitis). Check under your feet and toes before using the device
  - on, or close to, malignant tumours
  - on areas treated with radiotherapy (within the past 6 months)
  - on reproductive organs
  - on opposing thighs and refer to pad placement diagrams in this User's Manual for correct placement
- When using TENS do **not** apply to areas of skin that lack sensation
- Electrode pads are for single person use only. Do **not** share electrode pads with others
- Do **not** use electrode pads after their use-by date

## Warnings

### When applying foot-pads or electrode pads:

- There is a chance you may experience skin irritation or burns beneath the electrodes or hypersensitivity due to the electrical stimulation
- Ensure that any water based moisturiser is evenly applied and thoroughly absorbed into the skin before applying stimulation. There is a chance that uneven application could increase the risk of skin irritation or burn, when using the electrical stimulation
- Symptoms may worsen during the initial treatment phase before getting better. This may occur if the body has not fully adjusted to increased muscular activity and blood circulation. If this occurs, reduce the intensity and the duration of treatment which will reduce the initial symptoms. If symptoms persist consult with your doctor

### When not to use Revitive:

- Do not use the device:
  - In the presence of electronic monitoring equipment
  - Together with a life-supporting medical electronic device
  - When you are in the bath or shower
  - While you are sleeping
  - In conjunction with a brace or cast without first consulting with your doctor
- Use of this equipment adjacent to or stacked with other equipment should be avoided because it could result in improper operation. If such use is necessary, this equipment and the other equipment should be observed to verify that they are operating normally

### Additional Warnings:

- Use of accessories and cables other than those specified or provided by the manufacturer of this equipment could result in increased electromagnetic emissions or decreased electromagnetic immunity of this equipment and result in improper operation.
- Portable RF communications equipment (including peripherals such as antenna cables and external antennas) should be used no closer than 30 cm (12 inches) to any part of the Revitive System, including cables specified by the manufacturer

# Important safeguards

---



## Cautions

### When applying foot-pads or electrode pads:

- Be careful when applying stimulation over areas of skin that lack normal sensation. It may cause skin irritation due to the inability to feel stimulation until the intensity is too high. Use a low intensity to achieve a gentle muscle contraction, and/or use for a shorter time, to avoid over-stimulation. Check for signs of skin irritation (redness), bruising or pain. If in doubt consult your doctor
- This product is not intended for use by persons with reduced physical, sensory or mental capabilities, unless they are supervised by a person responsible for their safety

### When using EMS:

- Be careful when applying stimulation:
  - Over the abdomen during menstruation
  - After recent surgical procedures (within the past 6 months) as stimulation may disrupt your healing process
  - If your tissues are likely to bleed following an injury such as a muscle tear - it is recommended not to stimulate the immediate area within the first 12 hours after sustaining the injury. Use a low intensity and/or shorter time to avoid over-stimulation
  - After a long period of immobility or inactivity – use a low intensity and shorter time to avoid over-stimulation or muscle fatigue

### When using TENS:

- It is possible Revitive may reduce the sensation of pain that would normally act as a warning of an underlying problem
- If your pain does not improve, gets worse or continues for more than 5 days, stop using the device and seek advice from your doctor
- TENS is not effective in treating the original source or cause of pain

### Additional Cautions:

- The long term effects of electrical stimulation are unknown
- Electrical stimulation may not work for every user, please seek advice from your doctor



## Safety Precautions

- **Do not stand on the machine.** Use only when seated
- Do not position the Revitive so that it is difficult to disconnect or turn off
- Use the device only for its intended purpose
- Do not expose the device to extreme heat
- Do not spill liquid on the device or its accessories
- Do not overload the electrical socket
- Keep device out of the reach of children
- Keep power cords and cables out of the reach of children to prevent risk of strangulation
- Revitive foot-pads may be used by multiple persons. Ensure device is cleaned after each use
- During use, do not touch foot-pads with your hands until the paused feature is enabled or device has powered off
- Use Revitive only with the accessories supplied by, or purchased from, the manufacturer
- Check electrode pads, cords and cables periodically for damage
- Do not open Revitive or repair it yourself. This will invalidate your warranty and may cause serious harm
- In the unlikely event your Revitive malfunctions, disconnect it from the power source and contact your nearest authorised agent
- It has been reported that some universal remote control devices (e.g. for TV etc.) can change the settings on Revitive if used during a treatment. If this should occur, simply adjust the time or intensity settings on Revitive back to where you want them using the Revitive Remote Control, or using the device Control Panel
- Revitive has passed the required tests for Electromagnetic Interference (EMI); it may still be affected by excessive emissions and/or may interfere with more sensitive equipment
- After any exposure to hot or cold temperatures outside the specified operating range of 10 – 40°C allow the product to re-adjust to the recommended operating temperatures to ensure continued product performance

## Important safeguards \_\_\_\_\_

### Adverse Reactions

- If you experience adverse reactions, stop using Revitive and consult with your doctor immediately

## Instructions for use \_\_\_\_\_

### Step 1: Setting up Revitive for the first time

- a** Remove all parts from the box:
- AC/DC power adaptor
  - Revitive Medic device
  - Remote control
  - AAA batteries x 2
  - Small electrode pads
  - Electrode cord

See “What’s in the box?” on page 4 to help identify the parts.

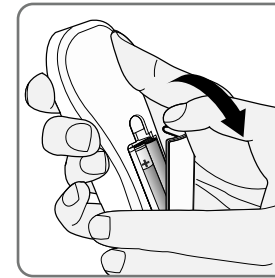

- b** Locate the remote control and insert the batteries.

**Before you use Revitive for the first time, read the Important Safeguards on pages 9-14. If in doubt, consult your doctor before using the product.**

# Instructions for use

## Step 2: Powering Revitive

Revitive can be powered from either the internal rechargeable battery or by connecting it to an electrical socket.

### Mains power option

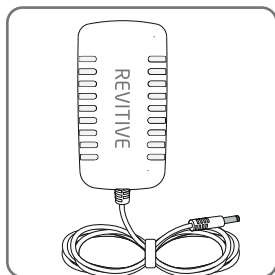

**a** Locate the AC/DC power adaptor.

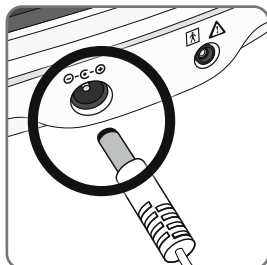

**b** Plug the small end of the power cord into the adaptor socket on the side of the device.

**c** Plug the power adaptor into the nearest electrical socket. This will also start charging the (integrated) rechargeable battery.

Once you have connected Revitive to the electrical socket, follow 'Step 3: Using the SoftTouch foot-pads' or 'Step 4: Using the dual mode electrode pads' to continue setting up Revitive.

### Battery power option

**a** Follow steps **a-c** in the mains power option. This will start charging the (integrated) rechargeable battery.

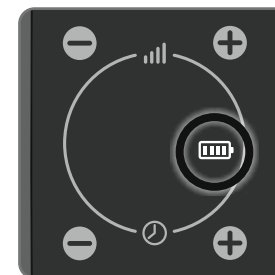

**b** When Revitive is switched off but on charge, the battery indicator icon will constantly scroll during charging; when the battery is full, scrolling will stop.

The battery indicator on Revitive indicates the battery's charge level.



**c** Once fully charged, the full battery indicator will stay illuminated until the power adaptor is unplugged from the device or the electrical socket.

A full charge will take approximately 3 hours.

A full charge enables approximately 3½ hours of use (the equivalent of one 30 minute session each day for one week).

When the device is running from the battery, an indicator will show the remaining battery level.

If you turn the device off and the low battery level indicator blinks for 10 seconds, the battery requires recharging.

**Please note you can use the device while it is charging but the battery indicator will not show**

# Instructions for use

## Step 3: Using the SoftTouch foot-pads

The SoftTouch foot-pads will deliver the Medic Program, with clinically proven and patented waveforms, to your feet and legs. You can use the electrode pads to receive EMS or TENS, see pages 20-25 for details.

### For best results:

- Use **Revitive foot-pads for at least 30 to 60 minutes each day**, 7 days a week. If you have varicose veins (CVI), use Revitive foot-pads for 60 minutes per day.
- It is important to use Revitive at a high enough intensity to give you a strong comfortable muscle contraction. Most people achieve a strong muscle contraction **over intensity level 40** (intensity range 1-99).
- If you are diagnosed with a long term medical condition such as High Blood Pressure, High Cholesterol, Diabetes, Osteoarthritis, Chronic Venous Insufficiency (CVI), Peripheral Arterial Disease (PAD) or COPD, it can take **up to 8 weeks** to help reduce symptoms associated with these chronic conditions.

Do not use Revitive, using EMS stimulation, for more than 6 sessions of 30 minutes (or the equivalent) per day.

- a** It is important that you are well hydrated. We recommend that you apply a moisturiser to the soles of the feet to help hydrate the skin and improve the delivery of electrical stimulation.

Please use a water based moisturiser such as the Revitive foot and leg cream.

Note: Very dry feet may cause Revitive to auto-pause, and stimulation will not be possible until the soles of your feet are hydrated. In this case it will be necessary to apply a moisturiser.

We also recommend drinking a glass of water before using Revitive.

**Sit with both bare feet on the foot-pads**

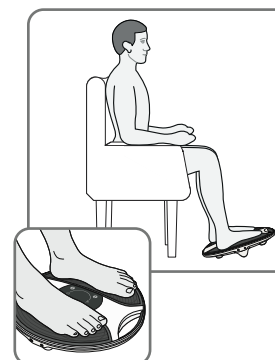

- b** Get into a comfortable seated position. For best results sit with your knees at a 90 degree angle (right angle).
- c** Place Revitive on the floor in front of you.

Revitive is designed to be used while seated. **Never stand** on the Revitive unit.

- d** Place **both bare** feet on the foot-pads. Make sure you remove all footwear, including socks/ stockings.

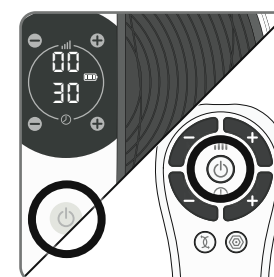

- e** Press the power button on the device or on the remote control to turn Revitive on.

You will hear a beep and the display will light up. The ⌚ time will read 30 minutes and 📶 Intensity will read 00.

To turn off Revitive at any time during operation, press the power button on the device or on the remote control.

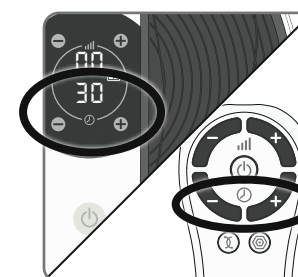

- f** Set the time for Revitive. The default time is 30 minutes. You can set the timer for up to 60 minutes.

If you do not want to use the default time of 30 minutes, set the time for the number of minutes you want. You can use the controls on the control panel or on the remote control.

Press the ⌚ (+) Time Control to increase the time. Press the ⌚ (-) Time Control to decrease the time.

# Instructions for use

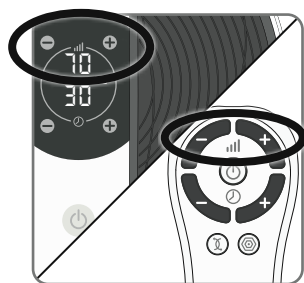

- g** Press the **|||| (+)** Intensity Control one time to start stimulation.

You can use the buttons on the control panel or remote control. Ensure both feet are on the foot-pads when increasing the intensity.

Press the (+) button to increase the level.  
Press the (-) button to decrease the level.

- h** Ensure you familiarise yourself with the feeling of the Medic Program. Use on a low intensity for 30-60 minutes once per day for a few days.

Set the intensity at a level where you can feel the stimulation in your feet which creates a calf muscle contraction.

It is normal to feel tingling or varying sensations in your feet and calf muscles.

Revitive does **not** vibrate.

- i** After a few days of familiarisation, use a higher intensity that provides you with **strong but comfortable calf muscle contractions**.

Most people experience a strong contraction at intensity level 40 or over.

The IsoRocker® enables Revitive to rock up and down once muscle contractions are nearing the desired level. The rocking is caused by muscle contractions in the leg, and the resulting ankle movement allowed by the IsoRocker is a good indicator that the intensity level is sufficient to provide the therapy. Increasing the intensity above this level will enhance the therapy, but should not be allowed to become uncomfortable.

You can set the intensity between 1-99.

Please note that the intensity required may vary from day to day.

If you feel pain or discomfort:

- Remove one or both feet from the foot-pads to stop the stimulation
- Lower the intensity of the foot-pads using the **|||| (-)** Intensity Control on the control panel, or remote control, before replacing your feet on Revitive

- j** If you remove one or both feet from the foot-pads, Revitive will pause the stimulation for up to 10 minutes. The display will blink on and off and you will hear a beep. The timer will stop until the session is resumed. Do not touch the foot-pads with your hands or pick up device until paused is enabled

The stimulation can be resumed by placing both feet back on the foot-pads and then pressing the **|||| (+)** button on the Intensity Control.

While Revitive is paused, the intensity level can be reduced by pressing the **|||| (-)** button on the Intensity Control.

Intensity cannot be increased while Revitive is paused.

After 10 minutes of being in the paused state, Revitive will switch itself off.

- k** The **⌚** Time Display will start to count down in minutes as Revitive cycles through its program.

- l** When Revitive times out, the **⌚** Time Display reads 00 and you will hear three beeps.



- m** Revitive switches itself off automatically.

# Instructions for use

## Step 4: Using the dual mode electrode pads



Electrode pads are for single person use only. Do **not** share electrode pads with others.

Full body pain management is achieved with the use of electrode pads, by selecting from two proven therapies  EMS and  TENS.

### 1. EMS Mode

Use Revitive electrode pads in  EMS mode for muscle strengthening and rehabilitation when required, from 30 minutes per day.

Do not use Revitive in  EMS mode for more than 6 sessions of 30 minutes (or the equivalent) per day. This may result in muscle fatigue.

Use at an intensity that provides you with **strong but comfortable muscle contractions**.

### 2. TENS Mode

It is recommended to use Revitive in  TENS mode for temporary pain relief from chronic joint, muscular, nerve or arthritic pain. Use for 20-30 minutes per session as and when required.

Use at an intensity that provides a **strong but comfortable tingling sensation** without causing you pain.

**The electrode pads cannot be used at the same time as the foot-pads. Using the electrode pads will automatically turn the foot-pads off.**

**Do NOT use the electrode pads on your head, face, neck or chest.**



a Select the area you wish to apply electrical stimulation to.

 Recommended placements are shown below:

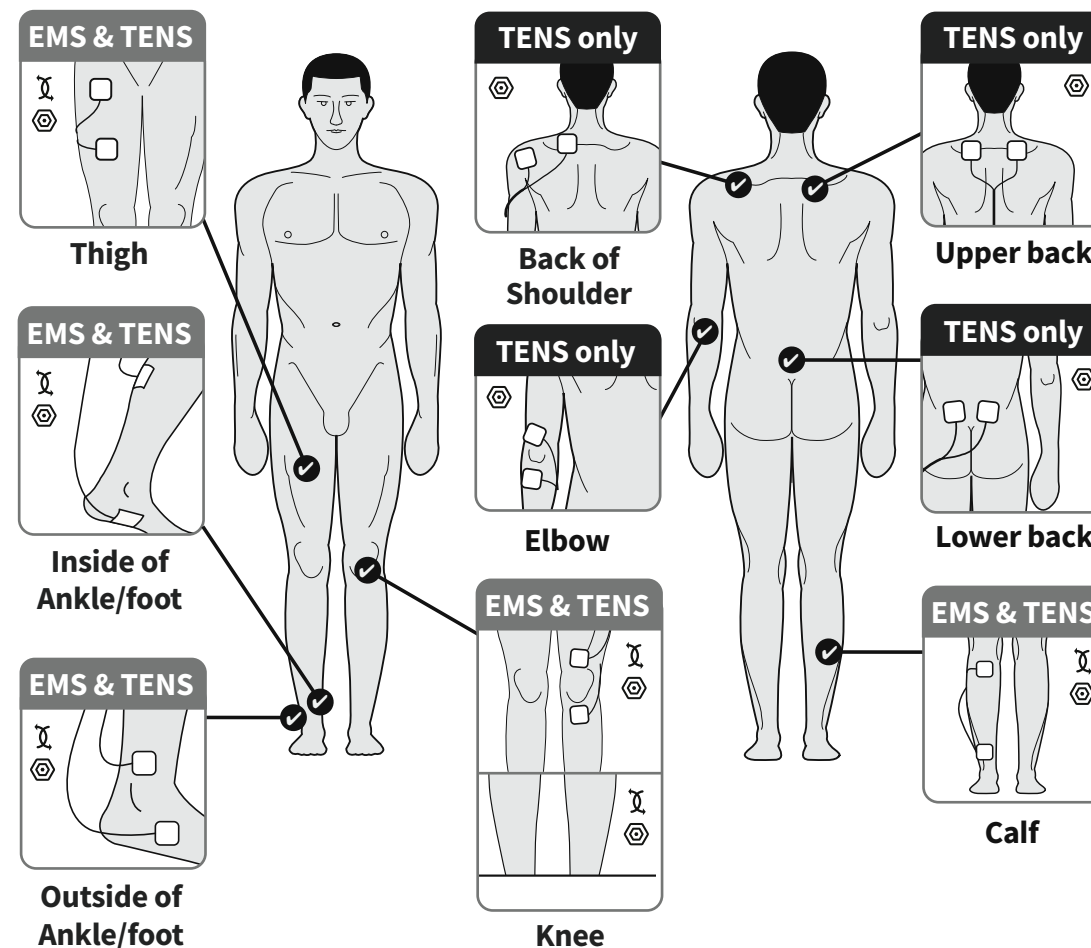

If using TENS for pain relief, position the electrode pads on either side of the area causing you pain.

# Instructions for use

**b** Clean and dry the area where you will place the electrode pads.

**c** Make sure Revitive is switched off. If the control panel is still illuminated, press the power button and turn Revitive off.

**d** Attach the ends of the electrode pads to the electrode cord.

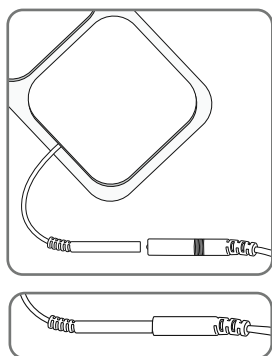

**Press connectors until there is no gap between them.**  
Leaving a gap may cause discomfort or no stimulation.

**e** Plug the other end of the electrode cord into the socket on the side of Revitive.

**Plugging in the electrode cord will automatically turn the foot-pads off.**

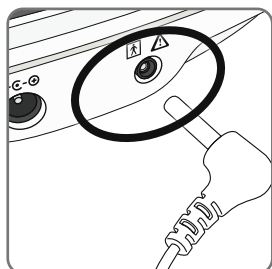

**f** Remove the plastic liner from the electrode pads, by peeling it off carefully. Replace the electrode pads onto the plastic liner after use.

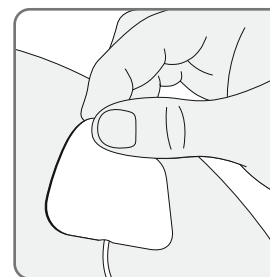
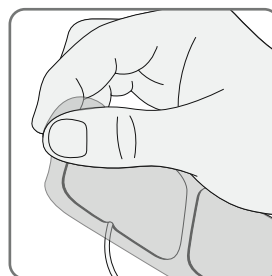

**g** Press the electrode pads on the area you wish to apply electrical stimulation to, as shown on page 23, gently pressing the adhesive side against the skin.

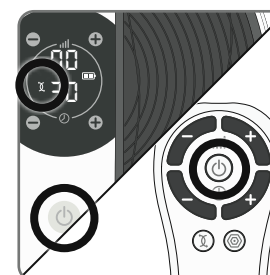

**h** Press the power button on the device or on the remote control to turn Revitive on. You will hear a beep and the display lights will light up. The ⌚ time will read 30 minutes, the 📶 Intensity will read 00 and the ⚡ EMS symbol will be displayed.



Revitive electrode pads will automatically provide stimulation in ⚡ EMS mode.

If you wish to use Revitive electrode pads in TENS Mode press the 🏠 TENS button on the remote control.

You will then see the 🏠 TENS symbol on the display.

See page 27 for further instructions on how to switch between EMS and TENS mode.

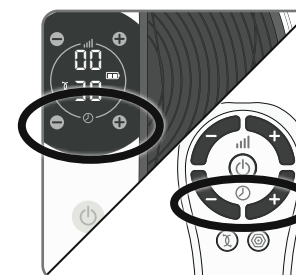

**i** Set the time for Revitive. The default time is 30 minutes. You can set the timer for up to 60 minutes

If you do not want to use the default time of 30 minutes, set the time for the number of minutes you want. You can use the controls on the control panel or on the remote control.

Press the ⌚ (+) Time Control to increase the time.  
Press the ⌚ (-) Time Control to decrease the time.

# Instructions for use

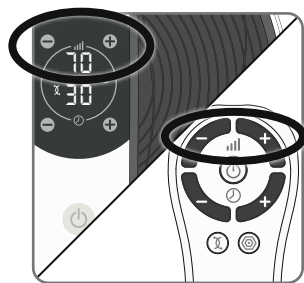

**j** Press the (+) Intensity Control once to start stimulation.

Continue to increase the intensity until you can feel the stimulation. You can set the intensity between 1-99.

You can use the buttons on the device or remote control. Press the (+) button to increase the level. Press the (-) button to decrease the level.

It is normal to feel tingling or varying sensations in the muscles you are treating.

Please note that the intensity required may vary from day to day.

If you feel pain or discomfort:

- Lower the intensity of the electrode pads using the (-) Intensity Control on the device or remote control.
- You can also choose to stop therapy before the end of the 30 minute session to avoid skin irritation and/or muscle fatigue. You can do this by pressing the power button on the device or on the remote control.

**k** The Time display will start to count down in minutes as Revitive cycles through its program.

When Revitive times out, you will hear three beeps, and the device will switch itself off automatically.

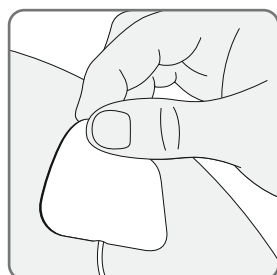

**l** Ensuring that the device is switched off, gently peel the electrode pads from the skin.

**Do not pull the electrode pads off the skin using the electrode cords as this may damage the cords.**

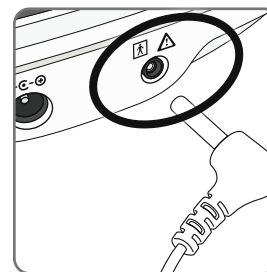

**m** Replace the electrode pads onto their plastic liner after use.

**n** Unplug the electrode cord from the socket on Revitive.

- The stimulation can be paused if necessary by unplugging the electrode cord from Revitive or from the pads. Revitive will pause for up to 10 minutes during which time you can re-connect and press (+) to re-start the stimulation.

After 10 minutes of being in the paused state, Revitive will switch itself off.

## Step 4.1: Switching between EMS and TENS mode

To change between EMS and TENS mode, press the button of the stimulation mode you require on the remote control.

You will see the mode selected highlighted on the display.

During use, switching from EMS to TENS mode (or vice versa), will reset the timer back to the relevant default time. The intensity will also be reset to zero.

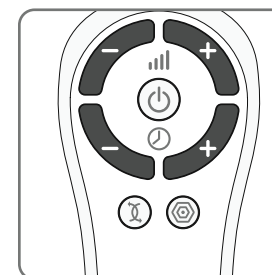

# Instructions for use

## Step 5: Cleaning and storing Revitive

- a** Ensure Revitive is switched off.
- b** Wipe down the foot-pads with a soft damp cloth.  
Do not clean with chemicals.  
Do not immerse Revitive in water.
- c** Store Revitive in a cool, dry and dust-free location.  
Store out of direct sunlight.
- d** Place electrode pads onto the plastic liner.
- e** Store the electrode pads in a dry and ventilated location.  
Store out of direct sunlight.  
You do not have to detach the electrode pads from the electrode cords to store them.

## Replacing the Batteries

The remote control requires two AAA 1.5V batteries to operate.

## Replacing the small electrode pads (2044)

The electrode pads are reusable up to 20-30 applications. If the electrode pads start to lose their adhesiveness, rub a few drops of water into the surface. Replacement electrode pads can be obtained via [www.revitive.com](http://www.revitive.com).

## Device disposal



Council directive 2012/19/EU concerning Waste Electrical and Electronic Equipment (WEEE) requires not to dispose of this device with other household wastes at the end of its working life. To prevent possible harm to the environment or human health from uncontrolled waste disposal, please separate this product from other types of wastes and recycle responsibly to promote the sustainable reuse of material resources.









Contact either the retailer where you purchased this product, or local government office, for details of where and how they can return this item for environmentally safe recycling.

# Troubleshooting

Problem	Possible Cause	Solution
<b>Revitive is on (lights illuminated on the LED display) but I cannot feel the electrical stimulation through the foot-pads.</b>	Not placing both bare feet on the foot-pads at the same time.	Ensure that your feet are bare and each foot is placed on each of the foot-pads at the same time. Keep increasing the <b>    </b> intensity up to a maximum of 99 until you feel the stimulation.
	Your feet may be dry.	Moisturise the soles of your feet to improve conductivity and stimulation and try the procedure again. You may also have to increase the <b>    </b> intensity level.
	You may be dehydrated.	Drink plenty of water before and after using the device. The device uses your body to create the electrical circuit. Water is an excellent conductor of electricity and if your body is less hydrated (below 60%) then the stimulation may be less, therefore it is important to always remain well hydrated.
	The <b>    </b> intensity level may be on too low a setting.	This is a very safe device. Keep increasing the <b>    </b> intensity level towards 99 until you feel the stimulation. You may find that you have to increase the intensity <b>    </b> level as you get used to the therapy. The aim is not to get to 99 but to find a setting that produces strong muscle contractions in your calves and is comfortable for you.
	Electrode cord is connected to device.	Disconnect the Electrode cord - the foot-pads will not work while the Electrode cord is plugged in.
	Revitive may be in auto-pause	Ensure that you have drunk plenty of water and that your feet are well moisturised. Place both feet onto the foot-pads, then press <b>     (+)</b> intensity button to resume stimulation.
	If, having tried the solutions above, you still cannot feel the stimulation:	Test the device by placing one hand across both foot-pads at the same time (The heel end of the foot-pads is easiest). With your other hand, and starting from zero, increase the <b>    </b> intensity level until you can feel the stimulation. If you can feel the stimulation through your hand then the device is working. If on 99 you still cannot feel the stimulation then please contact your authorised dealer.

# Troubleshooting

Problem	Possible Cause	Solution
<b>No power or lights to Revitive when it is switched on.</b>	AC Adaptor not switched on at the electrical socket or AC Adaptor not plugged into device properly.	Check electrical socket power is switched on and the AC Adaptor is plugged into the device correctly. If still not working – contact your authorised dealer.
	Flat battery	Plug device in an electrical socket and charge battery or run using mains power option.
<b>Revitive is not vibrating.</b>	<b>REVITIVE IS NOT DESIGNED TO VIBRATE.</b>	
<b>The IsoRocker® is not "rocking".</b>	It is the muscles in your legs that cause the "rocking", the IsoRocker® is a pivot.	The IsoRocker® will only rock when increased to an intensity which causes sufficient calf muscle contraction. It may be that you cannot comfortably increase the intensity high enough until you get used to the sensation. It is important that intensity is adjusted to a level that is comfortable.
	The device is too far in front of you.	Sit with your knees at a 90 degree angle.
<b>When using the IsoRocker® on a hard floor it makes a tapping noise.</b>	Incorrect positioning of the device or too high an intensity level.	Adjust the positioning of the device or lower the intensity level to reduce the device tapping. Alternatively use a floor mat under the device to cushion the sound.
<b>My legs are aching after treatment.</b>	You may have the  intensity on too high a setting and your muscles are being overworked.	Leave adequate time after each treatment to allow the muscles to recover (just like after vigorous exercise!). On your next session start on a lower setting (where you can feel the mild electrical stimulation and it is comfortable) and reduce the duration until your muscles have acclimatized to the stimulation.
<b>I have placed my feet on the device but am unable to see the TENS symbol on the control panel</b>	TENS is only available through the electrode pads.	

Problem	Possible Cause	Solution
<b>When using the electrode pads, the stimulation feels uncomfortable.</b>	The level of stimulation you are using may be too high or you may have broken skin.	Decrease the stimulation level using the  (-) intensity control on the device or remote control. You may need to discontinue use until skin has healed.
<b>I am unsure of which therapy mode I am using when using the electrode pads.</b>		Look at the display on the device. If the Electrode pads are in  EMS mode, you will see the  EMS symbol. If the Electrode pads are in  TENS mode, you will see the  TENS symbol.
<b>I suddenly can't feel stimulation when using the electrode pads.</b>	You may have pressed the other stimulation mode button by accident.	Pressing the opposite stimulation mode button (i.e. pressing the  TENS button when already in  EMS mode or vice versa), will reset the timer back to 30 minutes. The intensity will also be reset to zero. The mode, intensity and time settings will need to be re-made.
	You may have accidentally paused the stimulation session by disconnecting a pad.	Reconnect the pads to your body or re-connect the cord and press the  (+) to resume your session.

**For more information, including Frequently Asked Questions, please visit [support.revitive.com](https://support.revitive.com)**

# Technical Specifications

<b>Name of product</b>	Revitive Medic
<b>Model</b>	5573AQ
<b>Frequency</b>	EMS: 20Hz - 53Hz TENS: 80Hz - 130Hz
<b>Output current</b>	EMS: Max 15mA TENS: Max 19mA
<b>Weight</b>	1.4 Kg
<b>Dimensions</b>	360mm (Ø) x 76.5mm (D)
<b>Power consumption</b>	5W
<b>AC adaptor</b>	CE Approved
<b>Power source Input (adaptor used) Ⓢ Output Ⓢ</b>	100-240V $\sim$ AC (Ⓢ), 50/60Hz, 0.18A 5V (Ⓢ) DC $\text{---}$ , 1.0A
<b>Battery</b>	Lithium Ion, 1200mAh, 3.7V
<b>Battery Life</b>	500 charge cycles
<b>Applied parts</b> Parts of Revitive that in normal use come into physical contact with the user.	Small electrode pads - 5cm x 5cm = 25cm <sup>2</sup> SoftTouch Pads (Foot-Pads) - 253.69cm <sup>2</sup>
<b>Durable Period (Service Life) of Device and Remote Control</b>	4 Years

## The Remote Control replicates the controls found on the device

<b>Operating Frequencies</b>	38 KHz
<b>Operating Range Distance</b>	0 to 25m at horizontal 0 to 18m at +/- 30 degree angle from the horizontal.

## Output Specifications for Electrical Muscle Stimulation (EMS):

Waveform	Biphasic	
Shape	Square symmetrical with polarity reversal	
Maximum Output Voltage (+/-15%) @500Ω	Foot: 35Vp	Body: 19Vp
Pulse Duration (+/-10%)	Foot: 450-970μs	Body: 450μs
Net Charge @ 500Ω	[0.001]mC	
Maximum Power Density @ 500Ω	Foot: 0.414 mW/cm <sup>2</sup>	Body: 1.52 mW/cm <sup>2</sup>
ON Time (+/- 10%)	Foot: 1.90 - 8.30s	Body: 1.90 - 6.50s
OFF Time (+/- 10%):	Foot: 1.00 - 1.50s	Body: 1.00s

## Output Specifications for Transcutaneous Electrical Nerve Stimulation (TENS):

Waveform	Biphasic	
Shape	Rectangular	
Maximum Output Voltage: @ 500Ω	50V	
Pulse Duration:	100μs	
Net Charge (per pulse @ 500Ω)	0μC	
Maximum Average Power Density (@ 500Ω)	4.19 mW/cm <sup>2</sup>	

The values of PULSE DURATIONS, PULSE repetition frequencies and amplitudes, including any d.c. component, shall not deviate by more than ± 20 % when measured with a load resistance within the range specified.

If confirmation is required that Revitive works within its Essential Performance after a certain period of time, contact the manufacturer

### Humidity, temperature and air pressure limit for storage and transport

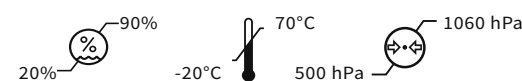

### Humidity, temperature and air pressure limit for operating conditions



After any exposure to hot or cold temperatures outside the specified operating range of 10 - 40°C allow the product to re-adjust to the recommended operating temperatures to ensure continued product performance.

# Technical Specifications

## Symbols

Refer to Instructional Manual Booklet		Center Positive Polarity	
Warning, Caution or Danger		Temperature range	
CE Mark of conformity with notified body number		Relative humidity range	
Date and country of manufacture		Atmospheric pressure range	
Legal manufacturer		Does not contain natural rubber latex	
Country importer & distributor		Power	
UK conformity assessed		Time remaining	
Serial number		Intensity level	
Catalogue number		EMS Mode	
Unique device identification reference		TENS Mode	
Model number		Battery indicator	
EU/EC European Authorised Representative		Indoor use only	
Medical Device		Do not disassemble	
Electrical Type BF equipment		Medical - applied current/energy equipment	
Class II medical electrical equipment double insulated		Green Dot® – Indicates that the producer has made a financial contribution towards the recycling and recovery of packaging in Europe.	
Ingress Protection Rating	IP21		
FCC mark			
RCM mark			
WEEE Directive conformity			

### Applies to electrode pads only

Expiry date	
Single user, multiple use medical device	

# Your 2-year warranty

It is important to retain the retailer's receipt as proof of purchase. Staple your receipt to this back cover for future reference.

Please quote the following information if the product develops a fault. These numbers can be found on the base of the product:

Model no: .....

Lot no: .....

All Revitive devices are individually tested before leaving the factory. In the unlikely event of any device proving to be faulty within 30 days of purchase, it should be returned to the place of purchase for it to be replaced.

If the fault develops after 30 days and within 24 months of original purchase, you should contact your local distributor quoting model number and LOT number on the product, or write to your local distributor at the address shown.

You will be asked to return the product (in secure, adequate packaging) to the address shown with a copy of proof of purchase.

Subject to the exclusions set out below (see Exclusions) the faulty device will then be repaired or replaced and dispatched, usually within 14 working days of receipt.

If, for any reason, this item is replaced during the 2-year guarantee period, the guarantee on the new item will be calculated from the original purchase date. Therefore, it is vital to retain your original till receipt or invoice to indicate the date of initial purchase.

To qualify for the 2-year guarantee, the device must have been used according to the manufacturer's instructions supplied.

## Exclusions

1 Actegy, manufacturer of Revitive devices, shall not be liable to replace the goods under the terms of the guarantee where:

- The fault has been caused or is attributable to accidental use, misuse, negligent use or used contrary to the manufacturer's recommendations or where the fault has been caused by power surges or damage caused in transit.
- The device has been used on a voltage supply other than that stated on the product or used with a power adaptor other than the one supplied with the product.
- Repairs have been attempted by persons other than our service staff (or authorised dealer).
- The device has been used for hire purposes or non-domestic use.
- The device is second hand.

2 Actegy are not liable to carry out any type of servicing work, under the guarantee.

3 Accessories such as electrode pads and bags are not covered by the guarantee.

4 Remote control batteries and any damage from leakage are not covered by the guarantee.

5 This guarantee does not confer any rights other than those expressly set out above and does not cover any claims for consequential loss or damage. This guarantee is offered as an additional benefit and does not affect your statutory rights as a consumer.

**To activate your free 2-year warranty please register your device at: [support.revitive.com](http://support.revitive.com)**

# REVITIVE®

## Medic



The Lightbox  
Bracknell, RG12 8FB  
United Kingdom.  
Tel: +44 (0)800 014 6377



**MDSS**  
Schiffgraben 41  
30175 Hannover, Germany.



**UK:**

Imported by and UK Responsible Person:  
Actegy Ltd  
The Lightbox  
Bracknell, RG12 8FB  
United Kingdom  
Tel: +44 (0)800 014 6377  
info.uk@actegy.com

Copyright © 2025 Actegy Ltd. All rights reserved. Actegy®, Revitive®, Revitive Medic®, Circulation Booster®, OxyWave®, IsoRocker® and SoftTouch Pads™ are trademarks or registered trademarks of Actegy Ltd. The Actegy product is a proprietary design and is protected by applicable design laws.

5603\_IFU05c\_20027692. P.D 11.2025



**CIRCULATION BOOSTER®**

[www.revitive.com](http://www.revitive.com)