

REVITIVE®



Medic Coach User's Manual



**Drug-Free
Clinically Proven
Certified Medical Device**



**Please read the
User's Manual carefully
before using this product**

USE ONLY AS DIRECTED
If symptoms persist, consult
your healthcare professional

Model number
5575AQ

CIRCULATION BOOSTER®

Table of contents

What's in the box?	3
Parts and controls	4
Introduction to Revitive	6
Operator Profile	6
Indications for use	7
Important safeguards	8
Do not use if (contraindications):	8
Warnings	9
Cautions	11
Safety Precautions	12
Adverse Reactions	12
Getting started	13
Step 1: Remove all parts from the box	13
Step 2: Charge Revitive	14
Step 3: Download the Revitive app and create an account	15
Step 4: Connect the app with your Revitive	16
Step 5: Set up your therapy plan	17
Introducing the Dashboard Screen	18
Using the foot-pads	19
Introducing the Controller Screen	20
Running & monitoring your therapy plan	24
Using the Dual Mode Body Pads	31
Using the Thigh Pads (purchase required)	35
Maintenance	38
Programs explained	39
Appendix	40
Troubleshooting	44
Technical Specifications	47
Your 2-year warranty	51

How-to videos

For videos of setup and using your Revitive system, go to:

support.revitive.com

2-year warranty

To activate your free 2-year warranty please register your device at:

support.revitive.com

What's in the box?

On opening the carton, please check that the following components are provided. If you think anything is missing, please contact us using the helpline numbers on the back of this booklet.

1 Revitive Medic Coach



2 Power adaptor Cable length 180cm

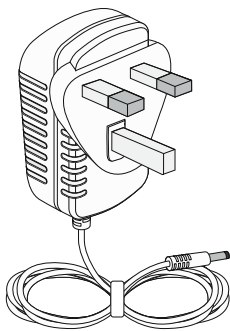

3 Electrode Body Pads

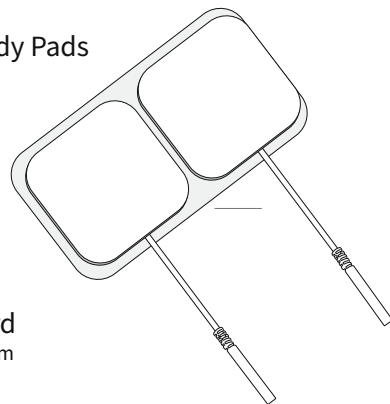

4 Electrode cord Cable length 150cm

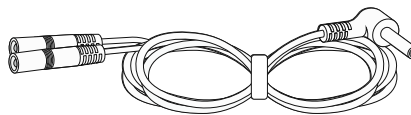

Parts and controls

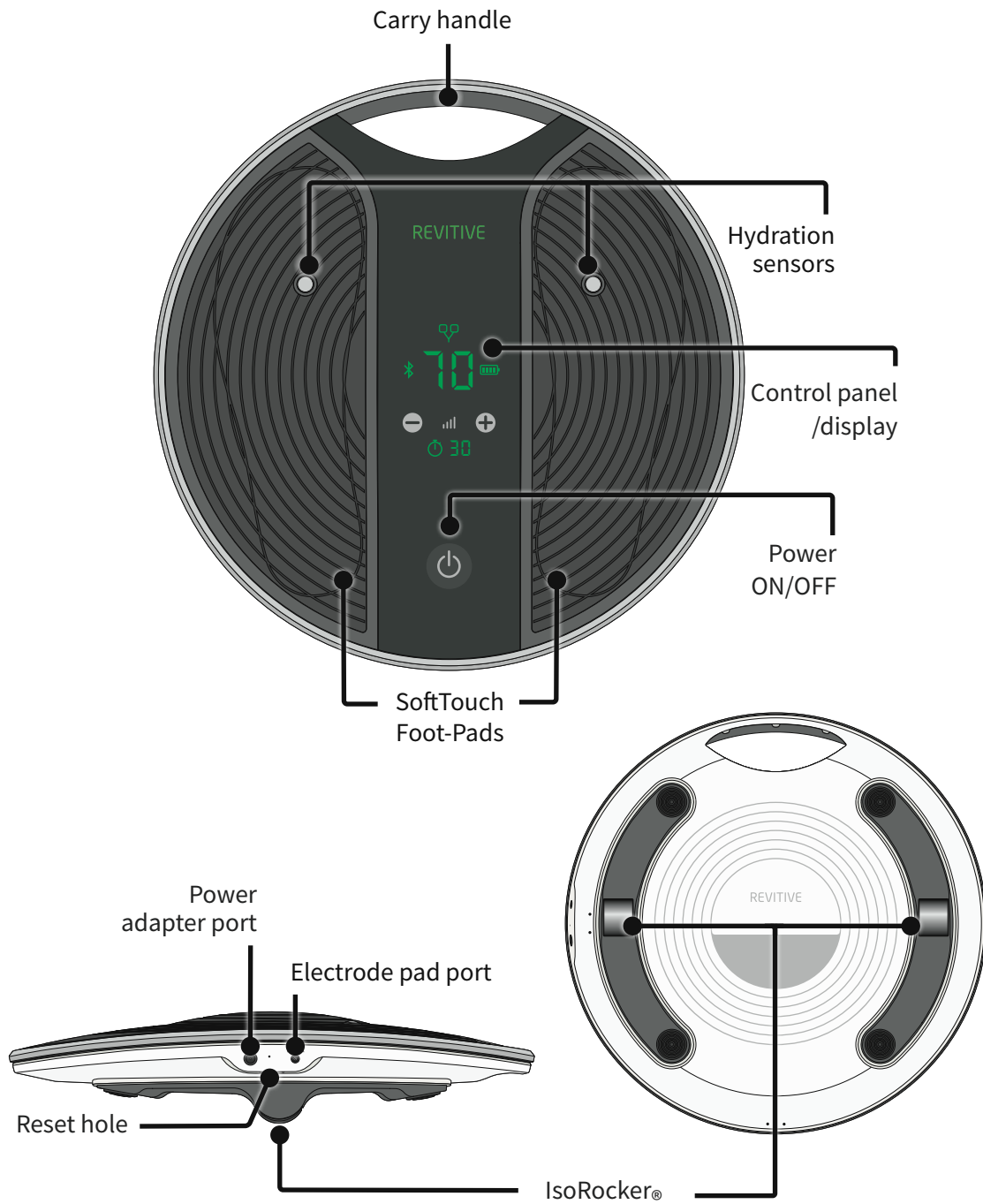

Parts and controls

Control panel on Revitive

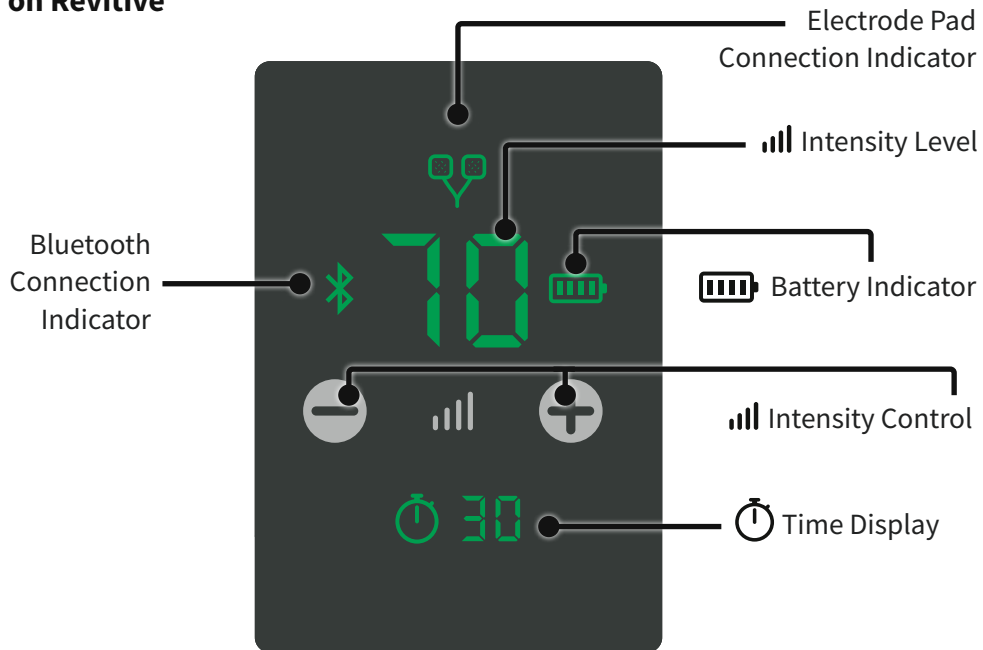

Revitive App

The Revitive app controls the Revitive device and manages all aspects of your therapy based on your personal symptoms and medical conditions.

The app is available for download from your phone's Play or App store. Wireless connection to the device is via Bluetooth.

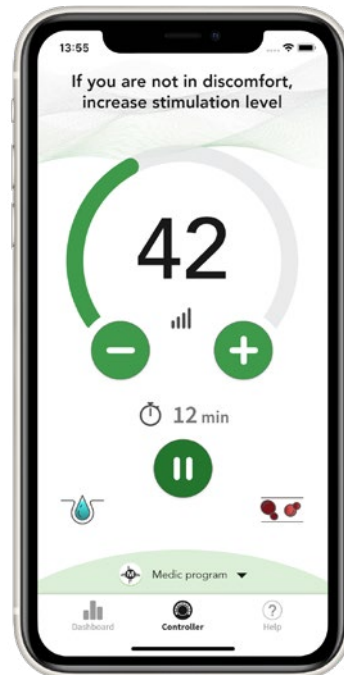

Introduction to Revitive

Operator Profile

The intended operator profile is based on users in the home environment who may suffer from immobility, osteoarthritis of the knee, poor circulation and related issues such as pain, leg stiffness and swelling in the legs, ankles and feet. It is also suitable for rehabilitation following knee-surgery.

Revitive is intended for use by the end user in a non-clinical setting and without the supervision or intervention of a clinician during use.

A typical user may be of any adult age range and is not specific to any demographic of gender, ethnicity or educational background.

Introduction to Revitive

Electrical Muscle Stimulation (EMS) Indications for use

When using the foot-pads, Revitive is intended to:

- Reduce pain and discomfort in the legs/ankles/feet - caused by poor circulation (Peripheral Arterial Disease).
- Improve circulation in the legs - caused by Peripheral Arterial Disease.
- Improve circulation to reduce or prevent blood-pooling (stasis) - caused by poor circulation (Chronic Venous Insufficiency/varicose veins).
- Increase walking distance before the onset of claudication symptoms (pain) – caused by Peripheral Arterial Disease.
- Improve symptoms associated with varicose veins/ Chronic Venous Insufficiency.
- Help maintain leg vein health - by increasing circulation, delivering more oxygenated-blood and reducing swelling (oedema) in the legs, feet & ankles.

When using electrode pads, applied to the legs, Revitive is intended to:

- Reduce pain and discomfort in the legs/ankles/feet - caused by Diabetic Peripheral Neuropathy, or swelling (oedema) due to osteoarthritis or following surgery
- Reduce swelling in the legs/ankles/feet - caused by being immobile due to osteoarthritis or an injury.
- Improve circulation to reduce or prevent blood-pooling (stasis) - caused by diabetes or by being immobile following surgery.
- Increase muscle strength to help regain mobility in the legs affected by being immobile due to COPD, osteoarthritis or following surgery.

If you are otherwise healthy and have a sedentary lifestyle or spend long periods inactive, Revitive may help to:

- Alleviate tired, aching & heavy legs, including cramp
- Help maintain leg vein health
- Actively increase circulation
- Reduce swollen feet & ankles
- Strengthen leg muscles

Transcutaneous Electrical Nerve Stimulation (TENS) Indications for use

When using electrode pads, Revitive is intended to provide:

- Temporary relief of pain of musculoskeletal or neuropathic origin
- Relief of arthritis-associated pain
- Relief and management of chronic pain, associated with musculoskeletal pain, osteoarthritis and fibromyalgia
- Relief of post-surgical and post-traumatic pain

The above Indications for Use are certified under the Medical Devices Directive 93/42/EEC.

Important safeguards

Read all instructions before use.

Save these instructions.

Revitive should not be used by some people.



Do not use if (contraindications):

- You are fitted with an electronic implanted device such as a heart pacemaker or Automatic Implantable Cardioverter Defibrillator (AICD)
- You are pregnant
- You are being treated for, or have the symptoms of, an existing Deep Vein Thrombosis (“DVT”)

Long periods of inactivity can put you at greater risk of developing Deep Vein Thrombosis (DVT). DVT is a blood clot and usually occurs in a deep leg vein. If part of the DVT breaks off it may lead to potentially life-threatening complications such as pulmonary embolism.

If you have been inactive for prolonged periods and suspect you may have a DVT, consult your doctor immediately. **To prevent dislodging the clot do not use Revitive.**

In some cases of DVT there may be no symptoms. However it is important to be aware of the symptoms that may include:

- Pain, swelling and tenderness in one of your legs (usually your calf)
- A heavy ache in the affected area
- Warm skin in the area of the clot
- Redness of your skin, particularly at the back of your leg, below the knee

Consult your doctor as soon as possible if you show any signs of the above symptoms.

Important safeguards



Warnings

Consult with your doctor before using this device if:

- You are in the care of a doctor
- You have a history of heart problems
- You have had medical or physical treatment for your pain
- You have suspected or diagnosed heart disease
- You have suspected or diagnosed epilepsy
- You are unsure about the suitability of Revitive for you
- You are unsure about the cause of your symptoms

If you have a metallic implant:

- If you have a metallic implant, you may experience pain or discomfort near the implant when applying electrical stimulation. If this should occur discontinue use and seek advice from your doctor
- The electrical stimulation may feel more intense close to a metallic implant. It is safe to continue use provided no pain is experienced. You may need to adjust the intensity to a comfortable level

When applying foot-pads or electrode Body/Thigh Pads:

- Do **not** use the electrode pads on your head, face, neck or chest
- Application of the electrodes near the thorax (chest) may increase the risk of cardiac fibrillation
- Only apply to areas with intact/unbroken skin
- Do **not** apply foot-pads or electrode pads directly or adjacent to these areas:
 - on cut or broken skin; open wounds or rashes; swollen, red, infected or inflamed areas; or skin eruptions (eg phlebitis, thrombophlebitis, varicose veins, cellulitis). Check under your feet and toes before using the device
 - over, or in proximity to (close to), cancerous lesions/malignant tumours
 - on areas treated with radiotherapy (within the past 6 months)
 - on reproductive organs
 - over the carotid sinus nerves (front of the neck), particularly in patients with a known sensitivity to the carotid sinus reflex
 - on opposing thighs and refer to pad placement diagrams in this User's Manual for correct placement
- When using TENS do **not** apply to areas of skin that lack sensation
- Electrode pads are for single person use only. Do **not** share electrode pads with others
- Do **not** use electrode pads after their use-by date
- There is a chance you may experience skin irritation or burns beneath the electrode pads or hypersensitivity due to the electrical stimulation
- Ensure that any moisturiser/gel/balm is evenly applied and thoroughly absorbed into the skin before applying stimulation. There is a chance that uneven application of a moisturiser/gel/balm could increase the risk of skin irritation or burn, when using the electrical stimulation

Important safeguards



Warnings

When applying foot-pads or electrode Body/Thigh Pads:

- Symptoms may worsen during the initial treatment phase before getting better. This may occur if the body has not fully adjusted to increased muscular activity and blood circulation. If this occurs, reduce the intensity and the duration of treatment which will reduce the initial symptoms. If symptoms persist consult with your doctor

When not to use Revitive:

- There are times you should not use Revitive. Do not use Revitive:
 - In the presence of electronic monitoring equipment
 - Together with a life-supporting medical electronic device
 - When you are in the bath or shower
 - While you are sleeping
 - In conjunction with a brace or cast without first consulting with your doctor.
- Use of this equipment adjacent to or stacked with other equipment should be avoided because it could result in improper operation. If such use is necessary, this equipment and the other equipment should be observed to verify that they are operating normally

Additional Warnings:

- Use of accessories and cables other than those specified or provided by the manufacturer of this equipment could result in increased electromagnetic emissions or decreased electromagnetic immunity of this equipment and result in improper operation
- Portable RF communications equipment (including peripherals such as antenna cables and external antennas) should be used no closer than 30 cm (12 inches) to any part of the Revitive System, including cables specified by the manufacturer
- The hydration sensor component of this device is made of a nickel-containing metal (stainless steel). Persons with a sensitivity or allergy to metals may suffer an allergic reaction to this component. Discontinue use if symptoms of an allergic reaction appear

Important safeguards



Cautions

When applying stimulation:

- Be careful when applying stimulation over areas of skin that lack normal sensation. It may cause skin irritation due to the inability to feel stimulation until the intensity is too high. Use a low intensity to achieve a gentle muscle contraction, and/or use for a shorter time, to avoid over-stimulation. Check for signs of skin irritation (redness), bruising or pain. If in doubt consult your doctor

When using EMS:

- Be careful when applying stimulation:
 - Over the abdomen during menstruation
 - After recent surgical procedures (within the past 6 months) as stimulation may disrupt your healing process
 - If your tissues are likely to bleed following an injury such as a muscle tear - it is recommended not to stimulate the immediate area within the first 12 hours after sustaining the injury. Use a low intensity and/or shorter time to avoid over-stimulation
 - After a long period of immobility or inactivity – use a low intensity and shorter time to avoid over-stimulation or muscle fatigue

When using TENS:

- It is possible Revitive may reduce the sensation of pain that would normally act as a warning of an underlying problem
- If your pain does not improve, gets worse or continues for more than 5 days, stop using Revitive and seek advice from your doctor
- TENS is not effective in treating the original source or cause of pain

Additional Cautions:

- This product is not intended for use by persons with reduced physical, sensory or mental capabilities, unless they are supervised by a person responsible for their safety
- The long term effects of electrical stimulation are unknown
- Electrical stimulation may not work for every user, please seek advice from your doctor
- In the unlikely event TENS or NMES output is lost, degraded or not responsive, the device will reset itself and the device output intensity will reset to '0'. Remove electrode body pads or your feet from the device and re-start the device by switching it off and then on again

Important safeguards



Safety Precautions

- **Do not stand on the machine. Use only when seated**
- Do not position Revitive so that it is difficult to disconnect or turn off
- Use Revitive only for its intended purpose
- Do not expose Revitive to extreme heat
- Do not spill liquid on Revitive or its accessories
- Do not overload the electrical socket
- Keep device out of the reach of children
- Keep power cords and cables out of the reach of children to prevent risk of strangulation
- Revitive foot-pads may be used by multiple persons. Ensure device is cleaned after each use
- During use, do not touch foot-pads with your hands until the paused feature is enabled or device has powered off
- Use Revitive only with the accessories supplied by, or purchased from, the manufacturer
- Check electrode pads, cords and cables periodically for damage
- Do not open Revitive or repair it yourself. This will invalidate your warranty and may cause serious harm
- In the unlikely event your Revitive malfunctions, disconnect it from the power source and contact your nearest authorised agent
- Revitive has passed the required tests for Electromagnetic Interference (EMI); it may still be affected by excessive emissions and/or may interfere with more sensitive equipment
- After any exposure to hot or cold temperatures outside the specified operating range of 10 – 40°C allow the product to re-adjust to the recommended operating temperatures to ensure continued product performance



Adverse Reactions

- If you experience adverse reactions, stop using Revitive and consult with your doctor immediately

Any serious incident that has occurred in relation to the device should be reported to the manufacturer.

Always Check the website [revitive.com](https://www.revitive.com) for latest contraindications and warnings.

Getting started

You will need to follow the steps in this section when you use Revitive for the first time. They will ensure that Revitive is set up correctly.

Step 1: Remove all parts from the box

Step 2: Charge Revitive

Step 3: Download the Revitive app to your phone and create a Revitive account

Step 4: Connect the app with your Revitive

Step 5: Set up your therapy plan

These steps are described in detail on the following pages.

Step 1: Remove all parts from the box

- Revitive Medic Coach device
- Power adaptor
- Electrode Body Pads x 1 pair
- Electrode cord

See 'What's in the box?' on page 3 to help identify the parts.

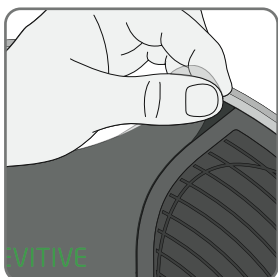

Remove protective film from the device and dispose of responsibly.
The device will not operate unless this is removed.

Getting started

Step 2: Charge Revitive

Revitive is powered from either the integrated rechargeable battery or by connecting it to an electrical socket. Ensure Revitive is charged before first use.

You can use an electrical socket at any time but this is essential when Revitive's battery power level is low. The battery recharges when Revitive is connected to an electrical socket and a stimulation program is not running. The battery indicator icon will constantly scroll during charging; when the battery is full, scrolling will stop.



The battery indicator on Revitive indicates the battery's charge level.



If you turn Revitive off and the low battery level indicator blinks for 10 seconds, the battery requires recharging.

The app will also warn you if Revitive's battery is low and needs charging.

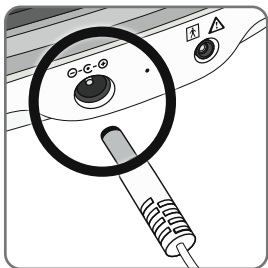

Plug the small end of the power adapter's power cord into the power adaptor port on the side of Revitive.

Plug the power adaptor into the nearest electrical socket. This will start charging the battery. Note that charging does not take place whilst a stimulation program is running.

A full charge will take approximately 4.5 hours.

Once fully charged, the full battery indicator will stay illuminated until the power adaptor is unplugged from the device or the electrical socket.

A full charge enables approximately 6 hours of use - 12x 30 minute sessions.

Getting started

Step 3: Download the Revitive app to your phone and create an account

You control Revitive and manage your therapy using the Revitive app.

You will need to download and install the app from the App Store or Google Play to your phone first.



Note: You will need to be connected to the internet to download the app and complete the setup process.

Note: The Revitive app is provided free of charge.

Note: Compatible with Bluetooth, Apple iOS and Android OS. Phones have various model numbers and operating system (OS) versions and not all of them may be compatible with the Revitive app. Version details can be found in your phone settings. If in doubt please visit support.revitive.com or check with the phone manufacturer.



Once the App has downloaded to your phone follow the instructions to set up your Revitive Account.

A Revitive account is required to secure your data and provide the appropriate therapies and guidance.

Note: The email address you want to use for your Revitive account must be available on your phone to be able to complete the email verification process.

To keep your personal information safe we recommend that you keep your phone up to date with the latest software from your phone manufacturer, and use identity confirmation like a PIN or fingerprint to secure your phone.

Getting started

Step 4: Connect the app with your Revitive

Connecting the app to your Revitive means you will be able to use your phone as a controller and you will be able to track your therapy.

- a** Check that Bluetooth on your phone is switched on. If you are unsure, go to Settings on your phone and look for Bluetooth, check that it is enabled.

Note that Android devices may ask whether the Revitive app can use Location Services. Please accept this as it's required for the Bluetooth connectivity to work as expected.

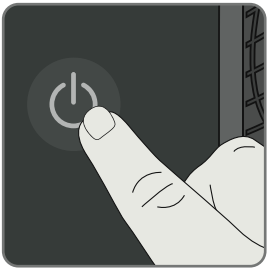

- b** As directed by the wizard, press and hold the **POWER** button on the Revitive device until you see the Bluetooth symbol  flashing on Revitive's control panel. This indicates that Revitive is in Bluetooth pairing mode and is ready to connect to your mobile phone.

Follow the pop-ups on screen.

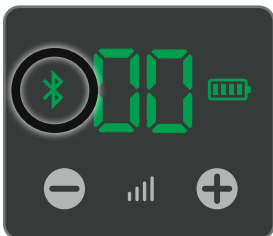

- c** After a short time, the app will find your Revitive and connect. When the connection is made, the Bluetooth symbol  on Revitive will stop flashing and remain illuminated.

The app will switch to display the Dashboard screen. If a problem occurs, please refer to the Troubleshooting guide on pages 44-46.

Getting started

Step 5: Set up your therapy

Follow the on-screen instructions to create your therapy plan

- **Key Symptom** - It is important that you enter this information correctly as your suggested Therapy Plan will primarily be based on it
- **Key Symptom Impact** - Thinking about the last few days, rate how much the symptom has impacted your daily life using the slider. Respond to any other questions
- **Other symptoms** - Select any other symptoms that you are experiencing
- **MyTherapy goal** - Set your own personal goal. Type in your own words what you hope to achieve as a result of completing the therapy
- **MyTherapy** - You will be presented with a summary of your suggested therapy plan based on the answers you have provided
- **Diagnosed conditions** - Select which of these conditions you have been diagnosed with by a medical professional. This section is for information only. By completing it you are contributing anonymously to help improve scientific research and product development
- **Notifications** - Set yourself reminders/alarms to help you keep on track
- **Steps** - Walking is an important measure of your progress. Allow Revitive to use your mobile phone to recognise physical activity.

Revitive will access your steps metrics from Google Fit or Apple Health and report on your activity in relation to your therapy plan and pain relief improvements.

Getting started

Introducing the Dashboard Screen

You will see the Dashboard screen every time you open the Revitive app.

You can always get back to the Dashboard by pressing . This will always be at the bottom of the screen, no matter where you are in the app.

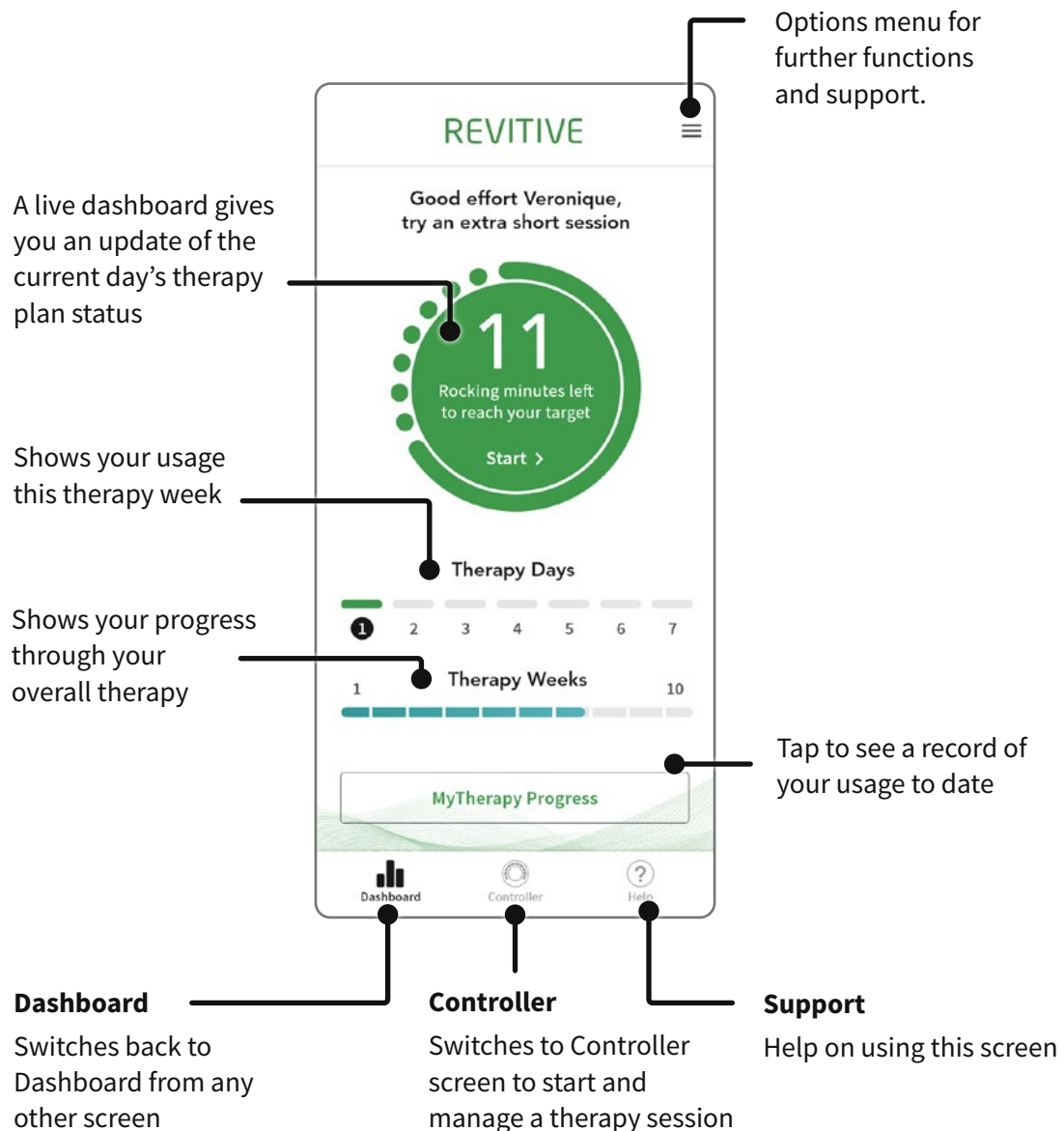

Using the foot-pads

On first use, the Training Program will be selected. This is a 10-minute foot-pad program that is intended to help you get used to the sensation of EMS stimulation and learn how Revitive rocks at the right intensity level. You can also set your preferred stimulation intensity level at the end of the program to enable the Auto Ramp-Up feature on your next therapy session. Once the Training program is complete, your main therapy can begin.

Please note that if you switch away from this app for any reason, simply reopen the app by tapping the  icon on your phone.

It is important that you are well hydrated. We recommend that you apply a moisturiser to the soles of the feet to help hydrate the skin and improve the delivery of electrical stimulation. We also recommend drinking a glass of water before using Revitive.

Sit with both bare feet on the foot-pads

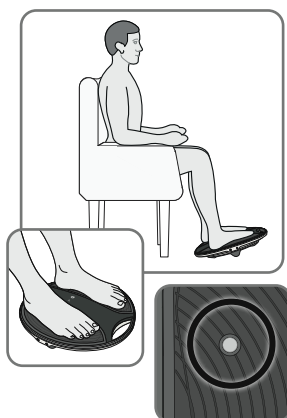

- a Get into a comfortable seated position.

For best results sit with your knees at a 90-degree angle (right angle).

Place Revitive on the floor in front of you.

Revitive is designed to be used while seated.

Never stand on Revitive.

Remove all footwear, including socks/stockings and then place both feet on the foot-pads, ensuring they cover the metal hydration sensors.

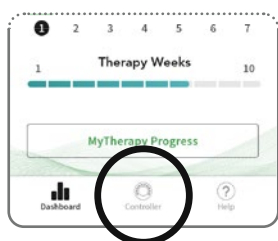

- b Tap  at the bottom of the screen.

Read and tap through the Usage Tips to reach the Controller screen.

Using the foot-pads

Introducing the Controller Screen

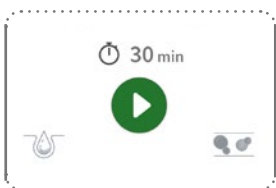
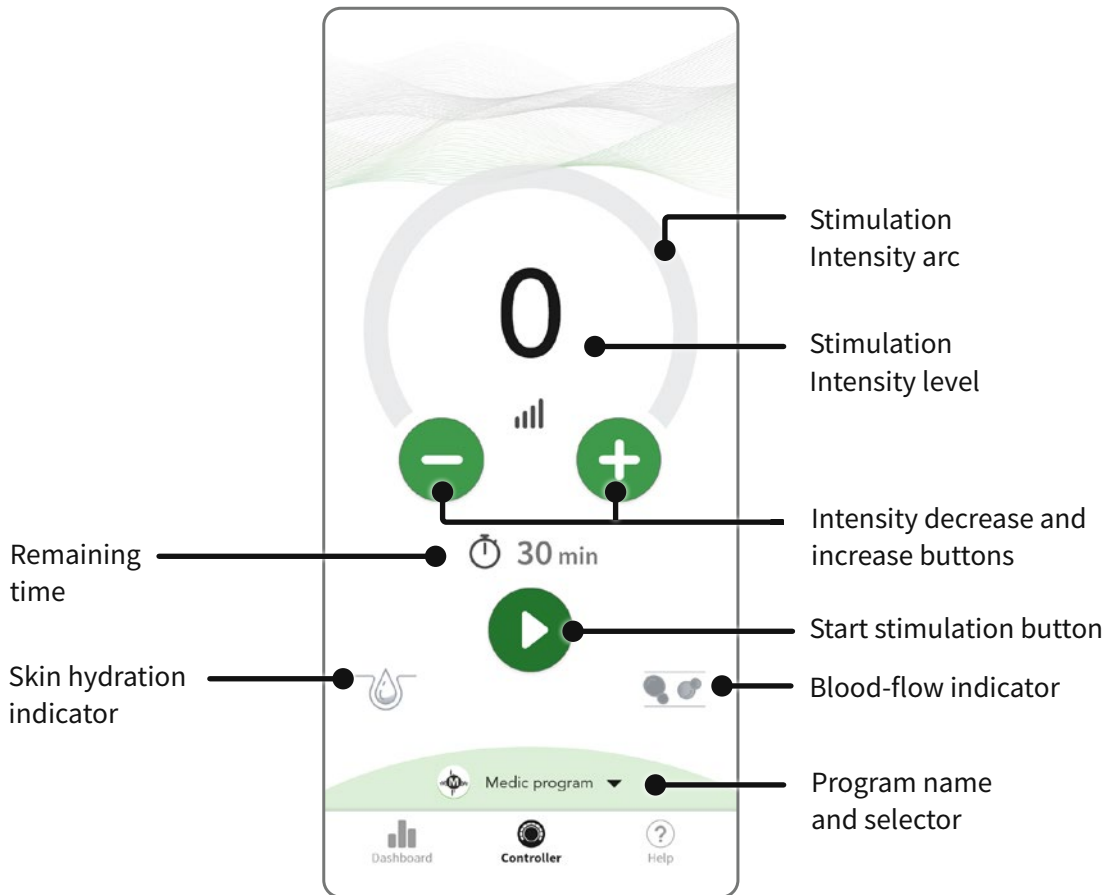

c Starting stimulation

Tap  to start a program, responding to any on screen questions.

Using the foot-pads

Usage tips

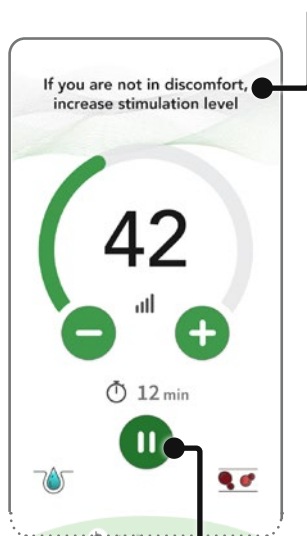

Pause stimulation button

d Adjusting the stimulation intensity

Tap the large green **-** or **+** buttons to manually decrease or increase the intensity in single units to a comfortable level. The intensity level is indicated by the coloured intensity level indicator on the arc and the large number inside the arc.

To quickly decrease or increase the intensity, tap and hold **-** or **+**.

When using the foot-pads you will be guided to the right intensity by indications and messages that appear on the screen. The intensity arc will also turn from orange to green when sufficient rocking movement is achieved.

If at any point during your therapy session, you stop rocking, a sound/vibration will alert you. To start rocking again, increase the intensity level by tapping the **+** button.

Note: Very dry feet may cause Revitive to auto-pause, and stimulation will not be possible until the soles of your feet are hydrated. If this happens, apply some moisturiser to the soles of your feet.

When using the Electrode Pads use at an intensity that provides you with **strong but comfortable muscle contractions**.

If you feel pain or discomfort: Lower the intensity of the foot/electrode pads using the intensity controls on the controller screen or the device.

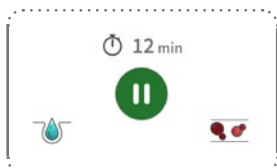

e Pausing and resuming stimulation

Tap **||** or remove your feet from the foot-pads.

When paused, the time display blinks in the app and on Revitive.

During a pause, you may reduce but not increase the intensity level.

Note that if paused for 10 minutes, the stimulation session ends and Revitive powers off. You will hear three beeps when your Revitive switches off.

To resume your therapy session, place both feet back on the pads and tap **▶** in the app to (or tap the button on Revitive).

You can tap **■** to stop the stimulation session.

Using the foot-pads

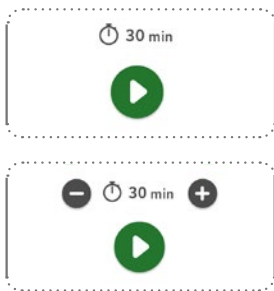

f Adjusting the duration of your program

The duration of the scheduled program is set automatically. The remaining stimulation time begins to count down in minutes as the program runs.

You can adjust the time at any point during a therapy session by tapping the 'remaining time' indication ⌚ to display the timer buttons.

Tap the grey + or - buttons to manually decrease or increase the duration of your scheduled program.

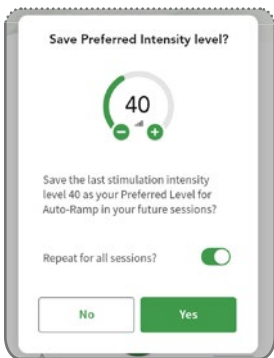

- g At the end of the session, the app will ask if you would like Revitive to remember the intensity level you reached for your next session using the Auto Ramp-Up feature.

About Auto Ramp-Up: Enabling Auto Ramp-Up aims to simplify use of your Revitive. When enabled Revitive will automatically increase the intensity level to your preferred level when you tap the Start ▶ button. You will not need to manually increase the intensity.

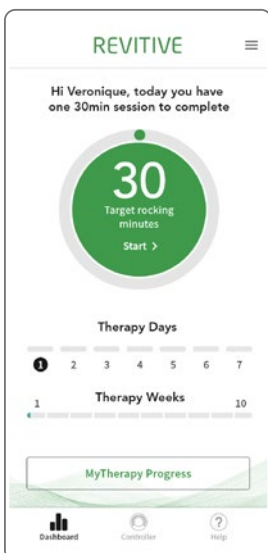

- h The app will switch to the Dashboard screen where you can view your suggested Therapy Plan.

You can complete your suggested Therapy sessions whenever it suits you. If you are unable to complete the session in one sitting you can stop and start throughout the day. Revitive will track how many minutes you have completed.

The device switches off after 10 minutes unless you revisit the Controller screen to start another program.

Using the foot-pads



- i The Programs are automatically selected as part of your suggested Therapy Plan. The program name is always displayed at the bottom of the Controller screen.

You can manually choose your Program by tapping the Program name when no stimulation is running.

Running & monitoring your therapy plan _____

View Your Therapy Plan Progress

Today's Progress

A live dashboard giving you an update of the current day's therapy plan status.



This Week's Progress



This is a line of 7 elements representing the 7 days of this week's therapy. Note that this is not a calendar week, but the weeks counted from the day you started the therapy. For example, if you started your therapy on a Thursday, then day 1 is Thursday of this week.

The colours have the following meanings:

Green

You completed your therapy session for this day and achieved the suggested intensity level and stimulation duration.

Total Therapy Progress



This is a line of 10 elements indicating how much time has elapsed since your 10-week suggested Therapy Plan started.

The progress above shows that therapy started 8 weeks and 5 days ago (5/7 of the seventh element is shaded) and that 1 week and 2 days (including today) remain.

Running & monitoring your therapy plan

Links to Activity, Awards, Key Symptom Impact and MyTherapy screens

Tapping the parts of the Dashboard screen shown below takes you to other sub screens.

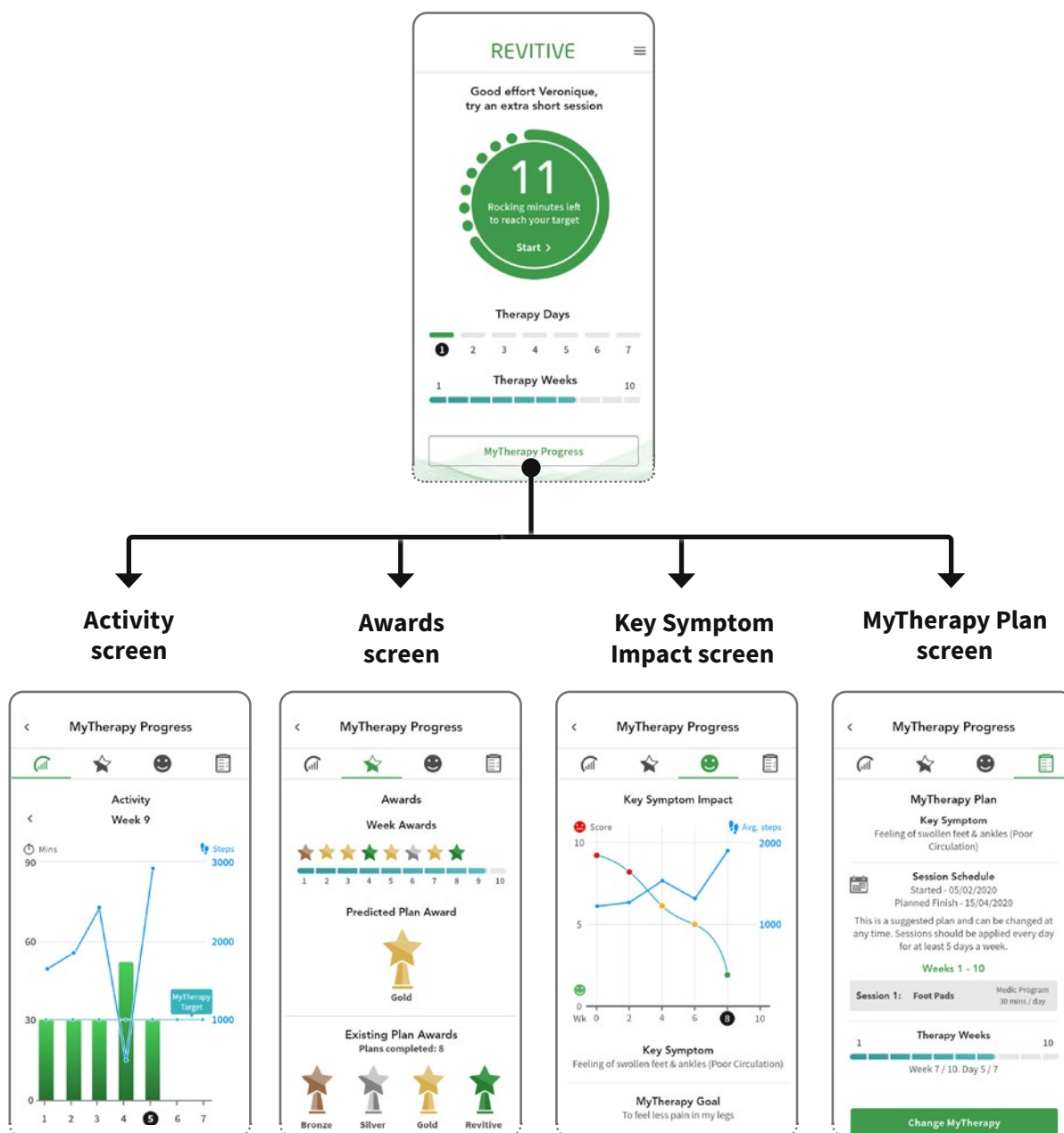

Running & monitoring your therapy plan

Activity sub screen

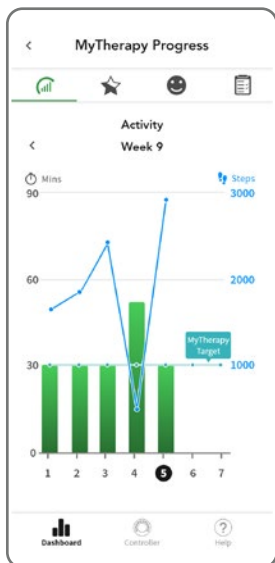

This displays your achieved stimulation durations in relation to the minimum suggested durations across the days in the current week or a previous therapy week.

It gives you an idea of how closely you are following your suggested Therapy Plan, and whether you need to increase your stimulation intensity levels or duration for the remaining therapy days.

If this is not the first week of therapy, you can tap the < icon at the top left of the screen to display activity for the previous week.

Day of the week

Day 1 on the scale is the day of the week on which you started your therapy program (for example, Thursday). The current day is highlighted.

Daily usage

Suggested daily usage is 2x30 mins per day. Do not use Revitive, using EMS stimulation, for more than 6 sessions of 30 minutes (or the equivalent) per day.

Therapy target

This shows the minimum suggested daily stimulation duration for each day of the selected week.

Actual duration

The height of a bar shows how long you used your Revitive on that day.

Steps

Your step count data is shown if you have enabled Steps access from Google Fit or Apple Health.

A green bar indicates that you reached your therapy target on that day by achieving both the suggested intensity level and stimulation duration.

An orange bar indicates that the therapy target was not reached on that day because either the intensity level for a Foot Pad program was too low or the total stimulation duration was below the minimum suggested duration. Use this to see how closely you are following your suggested therapy plan and whether you need to increase your stimulation intensity levels or duration for the remaining therapy days.

Tap ☆, 😊 or 📄 at the top of the screen to navigate to the other dashboard sub screens, or tap 📊 on the tab bar to return to the main Dashboard screen.

Running & monitoring your therapy plan

Awards sub screen



This displays the awards you have won on reaching the suggested therapy targets in your current MyTherapy Plan.

Use this to see how closely you are following your suggested plan.

Week Awards

This is a line of 10 elements displaying any awards you have achieved so far in each week of your 10-week MyTherapy plan

You win a week award on reaching the suggested stimulation durations on 3 or more days in that week.

3 days: Bronze award  **4 days:** Silver award 
5 days: Gold award  **6 days:** Revitive award 





Predicted Plan Awards

The plan award you are currently on target to achieve if your average usage continues at its current level.



Existing Plan Awards

This is your 'trophy cupboard' indicating the number of 10-week long suggested Therapy Plans you have completed since creating your Revitive account and the Plan Awards you have won.

Tap ,  or  at the top of the screen to navigate to the other dashboard sub screens, or tap  on the tab bar to return to the main Dashboard screen.

Running & monitoring your therapy plan

Key Symptom Impact sub screen

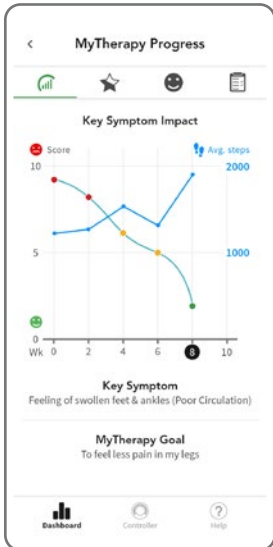

This displays a record of the level of impact your key symptom has had on your life, as reported by you at the two-weekly self-assessment points, throughout your therapy.

Use this to examine how your 10-week suggested Therapy Plan is alleviating your key symptom.

Self-assessed key symptom impacts

The graph displays the 'key symptom impact' score, which you assigned to your key symptom during each 2-weekly self-assessment in the selected Therapy Plan.

The highlighted week is the current week.

Changes in key symptom impact score

Each row indicates the score you gave at each 2-weekly self-assessment in the Therapy Plan:

Between 1 and 3 😊 Between 4 and 6 😐 Between 7 and 10 😞

Steps

Your average weekly step count data is shown if you have enabled Steps access from Google Fit or Apple Health.

Tap 🏠, ★ or 📄 at the top of the screen to navigate to the other dashboard sub screens, or tap 📊 on the tab bar to return to the main Dashboard screen.

Running & monitoring your therapy plan _____



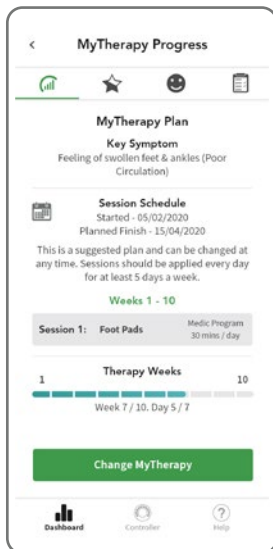

MyTherapy Plan sub screen



This is a summary indicating your key symptom, details of your suggested Therapy Plan and your progress.

In this screen you have the option to change your Therapy Plan should you wish to do so.

Changing your Therapy Plan, will require you to re-enter your key symptoms and any previous Therapy Plan progress will be lost.

Tap ,  or  at the top of the screen to navigate to the other dashboard sub screens, or tap  on the tab bar to return to the main Dashboard screen.

Running & monitoring your therapy plan _____

Options menu

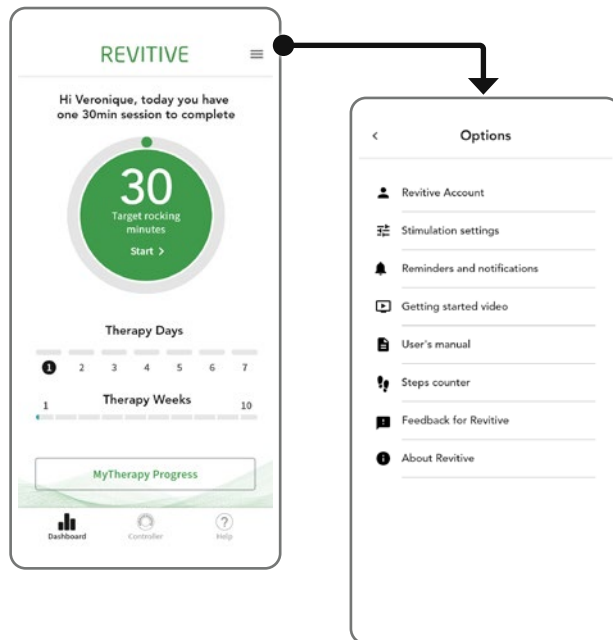

Tap the menu icon in the top right hand corner of the dashboard to access the options menu for further functions and support. From this menu you can also change your stimulation settings, reminders and notifications that have been previously set.

Using the Dual Mode Body Pads

Full Body Pain Management is achieved with the use of Electrode Body Pads, by selecting from two proven therapies EMS and TENS.

Body Pad EMS Program

Use the Body Pad EMS Program for muscle strengthening and rehabilitation when required, from 30 minutes per day.

Do not use Revitive in EMS mode for more than 6 sessions of 30 minutes (or the equivalent) per day. This may result in muscle fatigue.

Use at an intensity that provides you with **strong but comfortable muscle contractions**.

Body Pad TENS Program

It is recommended to use Revitive in TENS mode for temporary pain relief from chronic joint, muscular, nerve or arthritic pain. Use for 20-30 minutes per session as and when required.

Use at an intensity that provides a **strong but comfortable tingling sensation** without causing you pain.

This section explains how to apply and remove the electrode Body Pads when using any of the Body Pad programs from the Revitive app, or when using Revitive manually without the app.

**The Body Pads cannot be used at the same time as the foot-pads.
Using the Body Pads will automatically turn the foot-pads off.**

Do **NOT** use the Body Pads on your head, face, neck or chest.

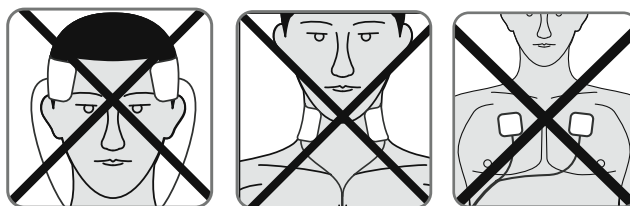

Using the Dual Mode Body Pads



Electrode Body Pads are for single person use only. Do **not** share Body Pads with others.

a Select the area you wish to apply electrical stimulation to.

☑ Recommended Body Pad placements are shown below:

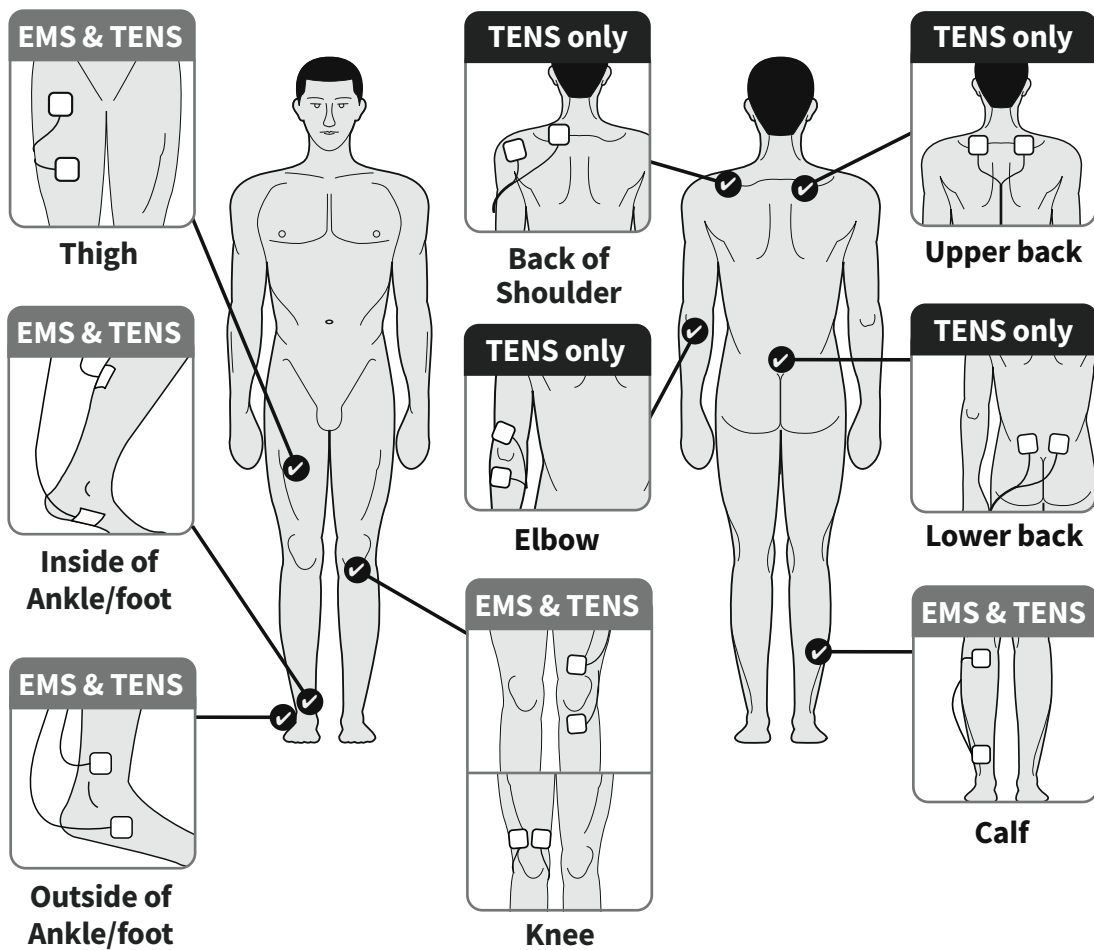

If using TENS for pain relief, position the Body Pads on either side of the area causing you pain.

Using the Dual Mode Body Pads

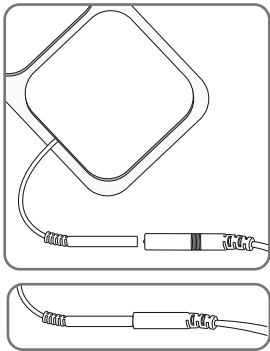

- b** Clean and dry the area where you will place the electrode pads.

Attach the ends of the electrode pad to the electrode cord.

See 'What's in the box?' on page 3 to help identify the parts.

Press the connectors firmly together .

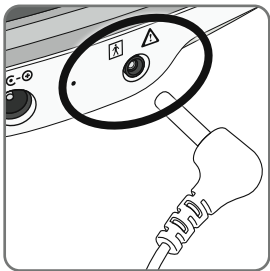

- c** **Making sure Revitive is switched off.** Plug the other end of the electrode cord into the electrode pad port on the side of Revitive.

Plugging in the electrode cord will automatically turn the foot-pads off.

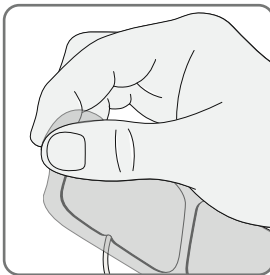

- d** Remove the plastic liner from the electrode pads. Put the liner to one side as you will re-use it after the session has ended.

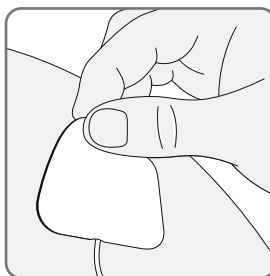

- e** Press the electrode pads on your chosen area, as shown on page 32 or the Thigh Pads as shown on page 36, gently pressing the adhesive side against the skin.



- f** Refer to pages 20-21 which explain how to control the stimulation from the app.

The Body Pad programs can be automatically selected as part of your suggested Therapy Plan or manually, by tapping the Program name at the top of the Controller screen when no stimulation is running.

Auto-pause will occur if a pad is disconnected from the body or a cable is disconnected. Reconnecting and tapping  will re-start the stimulation.

Using the Dual Mode Body Pads _____

Removing the electrode pads

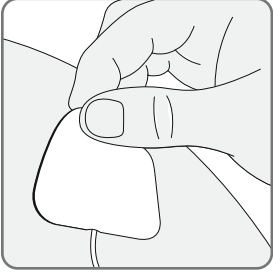

- a** Check Revitive is switched off after the session, then gently peel the electrode pads from the skin.

Do not pull the electrode pads off the skin using the electrode cords as this may damage the cords.

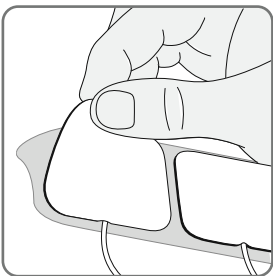

- b** Replace the electrode pads onto their plastic liner after use.

- c** Unplug the electrode cord from Revitive.

Using the Thigh Pads



Tap on the **i** next to the desired Knee Program. Follow the on-screen payment instructions to immediately unlock the Knee Programs and order your first Revitive Thigh Pads.

You can start using your Knee Program as soon as you receive your Thigh Pads.

If your Revitive Medic Coach was bundled with the Thigh Pads and the Knee programs already activated, these can be used straight away.

Knee Programs

Use the Knee Programs to strengthen the muscles at the front of your thigh (quadriceps). Strengthening your quadriceps muscles may help to support and stabilise the knee, reduce stress on the knee and relieve knee pain. Use Thigh Pads on the thigh of your affected leg (knee) once a day for 20 minutes, 5 days per week.

Do not use Revitive more than 6 sessions of 30 minutes (or the equivalent) per day. This may result in muscle fatigue. Use at an intensity that provides you with **strong but comfortable muscle contractions**.

There are three Knee programs to choose from:

Vigorous Knee Program

Provides a more intense muscle strengthening program for people who require less rest between their electrical muscle stimulation. The vigorous program delivers 10 seconds of stimulation, followed by a 10-second rest period which repeats until the end of therapy. Delivering 3 muscle contractions per minute.

Standard Knee Program

Provides our standard muscle strengthening program. The standard therapy program delivers 10 seconds of stimulation, followed by a 20-second rest period which repeats until the end of therapy. Delivering 2 muscle contractions per minute.

Gentle Knee Program

Provides a more relaxed muscle strengthening program, by offering a more substantial rest between muscle stimulation. The therapy session delivers 10 seconds of stimulation, followed by a 50-second rest period which repeats until the end of therapy. Delivering 1 muscle contraction per minute.

Using the Thigh Pads

This section explains how to apply the electrode Thigh Pads when using any of the Knee programs from the Revitive app.

It is important to use the Knee Program only with the large Revitive Thigh Pads.

Body Pads are not suitable for use with the Knee Programs.

The Thigh Pads cannot be used at the same time as the foot-pads.

Using the Thigh Pads will automatically turn the foot-pads off.

Do NOT use the Thigh Pads on your head, face, neck or chest.



Electrode Thigh Pads are for single person use only. Do **not** share Thigh Pads with others.

a Refer to steps b to d on page 33 for preparation before applying the thigh-pads

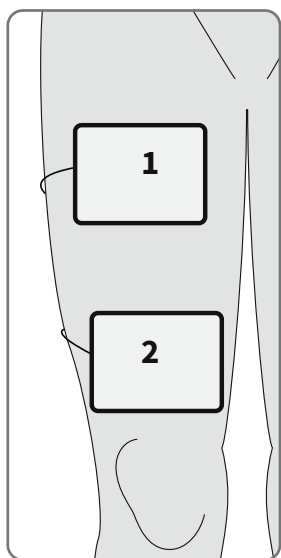

b Gently press one Thigh Pad across your thigh (1), a few centimetres away from your groin area, with the adhesive side against the skin.

Gently press second Thigh Pad across your thigh (2), a few centimetres from the top of your kneecap, with the adhesive side against the skin.

The Thigh Pads do not need to be lined up exactly with each other. They need to be in a position that is comfortable and that allows you to see your thigh muscles contract & relax.

Using the Thigh Pads

Adjusting the intensity level in the Knee Programs

At the start of each Knee Program there will be 30 seconds of stimulation to help you set the right intensity level. This is followed by a rest period of 30 seconds, when you will feel no stimulation. For the remainder of the therapy session you will feel the stimulation as described on page 35.

It is not possible to adjust the intensity during the rest periods. The app and device display will pulse, indicating a “pause”.

You can adjust the intensity when you can feel the stimulation being applied to your thigh and the app and device display are not pulsing.



- c Refer to pages 20-21 which explain how to control the stimulation from the app.

The Knee Pad programs can be automatically selected as part of your Suggested Therapy Plan or manually, by tapping the Program name at the top of the Controller screen when no stimulation is running.

Auto-pause will occur if a pad is disconnected from the body or a cable is disconnected. Reconnecting and tapping  will re-start the stimulation.

- d Remove and store the Thigh Pads by following the instructions on page 34.

Maintenance

Cleaning and storing Revitive

Ensure Revitive is switched off

Wipe down the foot-pads with a soft damp cloth.

Do not clean with chemicals.

Do not immerse Revitive in water.

Store Revitive in a cool, dry and dust-free location.

Store out of direct sunlight.

Place the electrode pads onto the plastic liner.

Store the electrode pads in a dry and ventilated location.

Store out of direct sunlight.

You do not have to separate the electrode pads from the electrode cords to store them.

Replacing the electrode pads

The electrode pads are reusable for up to 20-30 applications. If the pads start to lose their stickiness, rub a few drops of water into the surface.

Replacement electrode Body Pads and Thigh Pads can be obtained via www.revitive.com

Programs explained

Revitive Medic Coach Programs

These programs are included in your suggested Therapy Plan according to your key symptom and medical conditions.

Program	Description
Medic	This program includes our patented OxyWave® Technology, clinically proven to boost circulation and relieve symptoms associated with poor circulation. The specially selected waveforms are designed to stimulate muscle contraction and are delivered sequentially in 1-minute intervals to provide the best therapeutic benefit. To achieve the optimal results, a minimal of 30 minutes is recommended and is set as the default.
Vigorous	New intensive program delivers x2 increase in blood flow (projected based on Average in 30 healthy people during 30 min use), enabling greater oxygen-rich blood flow for maximum relief. The specially selected waveforms, including our patented OxyWave® Technology, are designed to stimulate muscle contraction and are delivered sequentially in 1-minute intervals to provide the best therapeutic benefit. To achieve the optimal results, a minimal of 30 minutes is recommended and is set as the default.
Body Pad EMS	This program consists of a specially designed waveform to provide muscle strengthening in the region of the applied Body Pads. The recommended program length is 30 minutes and this is set as the default.
Body Pad TENS	This program consists of a specially designed waveform to provide immediate and temporary relief of pain in the area of the applied Body Pads. The recommended program length is 30 minutes and this is set as the default.
Vigorous Knee Program	Available when electrode Thigh Pads are purchased. This program provides an intense muscle strengthening program for people who require less rest between their electrical muscle stimulation. The vigorous program delivers 10 seconds of stimulation, followed by a 10-second rest period which repeats until the end of therapy. Delivering 3 muscle contractions per minute. The recommended program length is 20 minutes and this is set as the default.
Standard Knee Program	Available when electrode Thigh Pads are purchased. The standard therapy program delivers 10 seconds of stimulation, followed by a 20-second rest period which repeats until the end of therapy. Delivering 2 muscle contractions per minute. The recommended program length is 20 minutes and this is set as the default.
Gentle Knee Program	Available when electrode Thigh Pads are purchased. This program provides a more relaxed muscle strengthening program, by offering a more substantial rest between muscle stimulation. The therapy session delivers 10 seconds of stimulation, followed by a 50-second rest period which repeats until the end of therapy. Delivering 1 muscle contraction per minute. The recommended program length is 20 minutes and this is set as the default.

Note: your session data is added to your usage history.

Appendix

Manual operation of Revitive

This section is about using Revitive manually without the Revitive app.

For best results, we recommend that you use Revitive with the app as described in earlier sections. Using with the app will deliver the best therapy for your symptoms and medical conditions.

It is important that you are well hydrated. We recommend that you apply a moisturiser to the soles of the feet to help hydrate the skin and improve the delivery of electrical stimulation.

Note: Very dry feet may cause Revitive to auto-pause, and stimulation will not be possible until the soles of your feet are hydrated. In this case it will be necessary to apply a moisturiser.

We also recommend drinking a glass of water before using Revitive.

Do not use Revitive, using EMS stimulation, for more than 6 sessions of 30 minutes (or the equivalent) per day. This may result in muscle fatigue.

Using the SoftTouch foot-pads

The foot-pads deliver EMS to your feet and legs only. The only program available in manual mode is the Medic Program.

Sit with both bare feet on the foot-pads

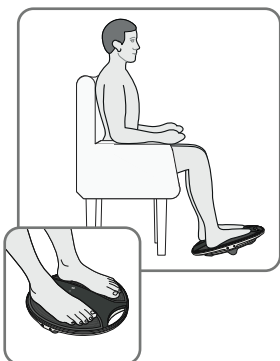

- a Get into a comfortable seated position.

For best results sit with your knees at a 90-degree angle (right angle).

Place Revitive on the floor in front of you.

Revitive is designed to be used while seated.

Never stand on Revitive.

Remove all footwear, including socks/stockings and then place both feet on the foot-pads.

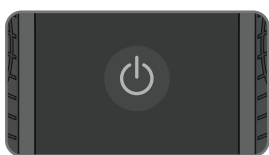

- b Press the power button on Revitive to turn it on.

Appendix



- c You will hear a beep and the display lights will light up. The time ⌚ will read 30 minutes and the 📶 Intensity will read 00.

Press the + Intensity Control button on the control panel to start stimulation. The ⌚ Time Display will start to count down in minutes as Revitive cycles through its program.

Press the + to increase the level.

Press the - button to decrease the level.

It is normal to feel tingling or varying sensations in your feet and calf muscles.

Revitive does **not** vibrate.

- d Ensure you familiarise yourself with the feeling of Electrical Muscle Stimulation (EMS). Use on a low intensity, for 30 minutes once per day or two 30-minute sessions a day, for a few days.

Set the intensity at a level where you can feel the stimulation in your feet which creates a calf contraction causing Revitive to rock back and forth on its IsoRocker.

After a few days of familiarisation, use a higher intensity that provides you with **strong but comfortable calf muscle contractions**.

Most people experience a strong contraction at intensity level 40 or over. You can set the intensity between 1 and 99.

Please note that the intensity required may vary from day to day.

If you feel pain or discomfort:

Remove both feet from the foot-pads to stop the stimulation.

Lower the intensity of the foot-pads using the 📶 intensity control on the control panel before replacing your feet on Revitive.

- e The foot-pad program will run for 30 minutes. You cannot change this time. To pause stimulation remove both feet from the foot-pads, when ready to resume stimulation place both feet back onto the foot-pads and press the + intensity control button.

Note that if paused for 10 minutes, the stimulation session ends and Revitive powers off. You will hear three beeps when your Revitive switches off.

To stop stimulation turn Revitive off by pressing the power button on Revitive.

Appendix

Using the Body Pads

Revitive comes with one pair of reusable (up to 20-30 applications) electrode Body Pads, which can be used to deliver Electrical Muscle Stimulation (EMS) to other parts of the body. The only program available in manual mode is the Body Pad EMS Program. If you wish to use TENS please download the App.

The Body Pads cannot be used at the same time as the foot-pads.

Using the Body Pads will automatically turn the foot-pads off.



Electrode Body Pads are for single person use only. Do **not** share Body Pads with other users.

Use the Body Pad EMS Program for muscle strengthening and rehabilitation when required, from 30 minutes per day.

Do not use Revitive in EMS mode for more than 6 sessions of 30 minutes (or the equivalent) per day. This may result in muscle fatigue

Use at an intensity that provides you with **strong but comfortable muscle contractions**.

It is important that you are hydrated. It is important that you are hydrated. We recommend moisturising your skin and drinking a glass of water before using Revitive.

Follow the instructions on pages 32-33 to apply the Body Pads

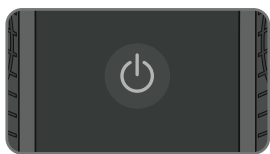

- a** Press the power button on Revitive to turn it on.



- b** You will hear a beep and the display lights will light up. Check that the Electrode Pads indicator is lit. The time ⌚ will read 30 minutes and the 📶 Intensity will read 00.

Press the + Intensity Control button on the control panel to start stimulation. The ⌚ Time Display will start to count down in minutes as Revitive cycles through its program.

Appendix

- c** Set the intensity at a level at which you can feel the stimulation creating a muscle contraction.

You can set the intensity between 1-99.

Please note that the intensity required may vary from day to day.

Press the **+** to increase the level.

Press the **-** button to decrease the level.

If you feel pain or discomfort:

- Lower the intensity of the Body Pads using the **-** Intensity Control on the device.
- You can also choose to stop therapy before the end of the 30-minute session to avoid skin irritation by pressing the power button on Revitive.



- d** When Revitive times out, you will hear three beeps and Revitive will switch itself off automatically.

- e** Remove and store the Body Pads by following the instructions on page 34.







Troubleshooting

Problem	Possible Cause	Solution
Revitive is plugged in but there is no power or lights.	The protective film is still in place. The device will only work if this film is removed.	Remove the protective film and dispose of it responsibly.
	Power adaptor not switched on at the electrical socket or not plugged into the device properly.	Check electrical socket power is switched on and the power adaptor is plugged into Revitive correctly. If still not working – contact your authorised dealer.
	Flat battery.	Plug device into an electrical socket and charge battery or run using mains power option.
My phone will not pair with Revitive despite going through Revitive app's pairing steps and no solid Bluetooth icon on Revitive	Phone's Bluetooth not configured correctly	<ol style="list-style-type: none"> 1. Ensure the phone has an internet connection by wifi or cellular (Data must be enabled on the phone) 2. Make sure Bluetooth is enabled in the Phone Settings 3. For iOS: Make sure Bluetooth is enabled for the Revitive app – Settings > Revitive 4. Ensure that Location Services are enabled on the phone – typically in Settings > Privacy (iOS) or Security and Privacy (Android). This is needed for Bluetooth pairing 5. For Android: Ensure that Location services are authorised for the Revitive app - typically in Settings> Apps > Revitive 6. Go to the Bluetooth Settings in the Phone and Forget/Unpair any Revitive devices listed in MY DEVICES (iOS) or PAIRED DEVICES (Android) 7. Start Revitive App again. 8. Reject any pairing requests you may see before you get to the instructions in the Revitive app for pairing 9. Follow the RevitiveApp's pairing instructions in the app for pairing and put the Revitive device into pairing mode as advised (flashing Bluetooth icon on the Revitive device) 10. Press "PAIR" in app and accept any pairing requests that now appear.
I tried pairing as instructed but it failed with an error message	Secure Bluetooth pairing flow had unexpected event	Try pairing again following the steps 1-10 above
Pairing failed but the Bluetooth icon is permanently on, on Revitive	Your Revitive is already connected to another phone via Bluetooth	You need to remove the connection from the other phone before you will be able to connect to your Revitive. Go to the other phone and shut down the Revitive
I have more than one Revitive and I can't connect to the one I want to use	Your phone is always connecting to the other Revitive	Remove any pairings to Revitive devices in Settings>Bluetooth and take the Revitive that is not required out of Bluetooth range
Pairing continues to fail and I have tried all the previous solutions		<p>Switch on Revitive device and insert a pin or unfolded paper clip into the Reset hole on its side until "00" appears in its display.</p> <p>Follow instructions above for Bluetooth not configured correctly.</p>

Troubleshooting



Problem	Possible Cause	Solution
Revitive is on (lights illuminated on the LED display) but I cannot feel the electrical stimulation through the foot-pads.	Not placing both bare feet on the foot-pads at the same time.	Ensure that your feet are bare and each foot is placed on each of the foot-pads at the same time. Keep increasing the intensity up to a maximum of 99 until you feel the stimulation.
	Your feet may be dry.	Moisturise the soles of your feet to improve conductivity and stimulation and try the procedure again. You may also have to increase the intensity level.
	The intensity level may be on too low a setting.	This is a very safe device. Keep increasing the intensity level towards 99 until you feel the stimulation. You may find that you have to increase the intensity level as you get used to the therapy. The aim is not to get to 99 but to find a setting that produces strong muscle contractions in your calves and is comfortable for you.
	The electrode cord is connected to device.	Disconnect the electrode cord - the foot-pads will not work while the electrode cord is plugged in.
	Revitive may be in auto-pause.	When the stimulation is paused, sections of the display on the app and Revitive pulse. Tapping  resumes the stimulation and tapping  ends the stimulation session. Ensure that you have drunk plenty of water, that your feet are well moisturised and both feet are placed on the foot-pads.
	If, having tried the solutions above, you still cannot feel the stimulation:	Test the device by placing one hand across both foot-pads at the same time (The heel end of the foot-pads is easiest). With your other hand, and starting from zero, increase the intensity level until you can feel the stimulation in your hand. If you can feel the stimulation through your hand then the device is working. If on 99 you still cannot feel the stimulation then please contact your authorised dealer.
Revitive is not vibrating.	REVITIVE IS NOT DESIGNED TO VIBRATE.	
Revitive is not "rocking".	It is the muscles in your legs that cause the "rocking", the IsoRocker® is a pivot.	Revitive will only rock when increased to an intensity which causes sufficient calf muscle contraction. It may be that you cannot comfortably increase the intensity high enough until you get used to the sensation. It is important that the intensity is adjusted to a level that is manageable.
	Revitive is too far in front of you.	Sit with your knees at a 90 degree angle.
When Revitive is rocking on a hard floor it makes a tapping noise.	Incorrect positioning of Revitive or too high an intensity level.	Adjust the positioning of Revitive or lower the intensity level to reduce Revitive tapping. Alternatively use a floor mat under Revitive to cushion the sound.
My legs are aching after treatment.	You may have set the intensity too high and your muscles are being overworked.	Leave adequate time after each treatment to allow the muscles to recover (just like after vigorous exercise!). On your next session start on a lower setting (where you can feel the mild electrical stimulation and it is comfortable) and reduce the duration until your muscles have acclimatized to the stimulation.

Troubleshooting

Problem	Possible Cause	Solution
When using the electrode pads, the stimulation feels uncomfortable.	The level of stimulation you are using may be too high or you may have broken skin.	Decrease the stimulation level using the  intensity control on the app or the  intensity control on Revitive. You may need to discontinue use until your skin has healed.
I am unsure which program is selected.		The selected program is displayed at the top of the Controller screen.
I suddenly can't feel stimulation when using the electrode pads	You may have accidentally paused the stimulation session either by disconnecting a pad, a cord or by pressing the pause button.	When the stimulation is paused, sections of the display on the app and Revitive pulse. The app will be showing the Start  or Stop  buttons. Tapping  resumes the stimulation and tapping  ends the stimulation session. You will need to re-connect the pads to your body or re-connect the cord to be able to resume.
When using the Thigh Pads, my thigh muscles are aching before the end of the treatment.	Your muscles may not yet be strong enough to carry out a full 20-minute session.	End the session before the end of the 20 minutes. On your next session start on a lower setting (where you can feel the mild electrical stimulation and it is comfortable) and reduce the duration until your muscles have acclimatised to the stimulation.
When using the Thigh Pads, I can't feel the stimulation in my thigh.	Therapy has started and has reached the rest period.	Depending on which program you are running you will need to wait for up to 10, 20 or 50 seconds before the stimulation will start again.

For more information please visit support.revitive.com

Technical Specifications

Name of product	Revitive Medic Coach
Model	5575AQ
Frequency (+/- 10%)	EMS: 20Hz – 53Hz TENS: 80Hz - 130Hz
Output current	EMS: Max 15mA TENS: Max 19mA
Weight (+/- 0.5kg)	1.5kg
Dimensions	360mm (Ø) x 76.5mm
Power consumption	5W
AC adaptor	CE Approved
Power source Input (adaptor used) ⚡ Output ⚡	100-240V  AC (⚡), 50/60Hz, 0.18A 5V (⚡) DC  , 1.0A
Battery	Lithium Ion, 2600mAh, 3.7V
Battery Life	300 charge cycles
Applied parts Parts of Revitive that in normal use come into physical contact with the user.	Electrode Body Pads - 5cm x 5cm = 25cm ² Electrode Thigh Pads - 10cm x 12.5cm = 125cm ² SoftTouch Pads (Foot-Pads) - 253.69cm ²
Durable period (service life) of device	4 Years

Bluetooth General Specifications

Standard Compliance	Bluetooth 5.0
Frequency Band	2.402 to 2.480 GHz
Modulation Method	GFSK

The Revitive app allows you to control Revitive from your phone device

Operating Frequencies	Bluetooth
Operating Range Distance	Up to 30 metres

Technical Specifications

Output Specifications for Electrical Muscle Stimulation (EMS):

Waveform		Biphasic	
Shape		Square symmetrical with polarity reversal	
Maximum Output Voltage (+/-15%)	@500Ω	Foot: 26 - 35Vp	Body: 18 - 32.6Vp
Pulse Duration (+-10%)		Foot: 450 or 970μs	Body: 450μs
Net Charge	@ 500Ω	[0.001]mC	
Maximum Power Density	@ 500Ω	Foot: 0.414 mW/cm ²	Body: 1.52-3.82 mW/cm ²
ON Time (+/- 10%)		Foot: 1.90 - 8.30s	Body: 1.90 -33.0s
OFF Time (+/- 10%)		Foot: 1.00 - 1.50s	Body: 1.00 - 47.0s

Output Specifications for Transcutaneous Electrical Nerve Stimulation (TENS):

















Waveform		Biphasic
Shape		Rectangular
Maximum Output Voltage	@ 500Ω	50Vp
Pulse Duration		100μs
Net Charge (per pulse @ 500Ω)		0μC
Maximum Average Power Density (@ 500Ω)		4.19 mW/cm ²

The values of PULSE DURATIONS, PULSE repetition frequencies and amplitudes, including any d.c. component, shall not deviate by more than ± 20 % when measured with a load resistance within the range specified.

If confirmation is required that Revitive works within its Essential Performance after a certain period of time, contact the manufacturer











Technical Specifications

Symbols

Complies with European Medical Devices Directive (93/42/EEC)	
UK Conformity Assessed Product conforms to all applicable U.K. legislative requirements.	
Device Lot number including year (YYYY) and month (MM) of manufacture can be found on the box and back of unit	 #YYYYMMXXXXX
Revitive Indication Number	
Item number	
Contraindications, Warnings and Cautions Make sure you understand these before using Revitive	
Power	
Time Remaining	
Intensity Level	
Electrode pads indicator	
Battery Indicator	
Bluetooth Enabled	
FCC mark Certification mark employed on electronic products manufactured or sold in the United States which certifies that the electromagnetic interference from Revitive is under limits approved by the Federal Communications Commission	
RCM Mark The equipment complies with Radio Communications and EMC requirements for Australia and New Zealand	
Center Positive Polarity	
Class II medical electrical equipment double insulated	

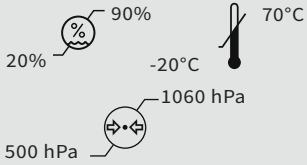
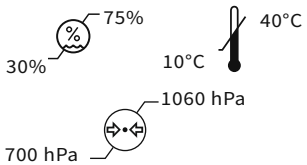
Technical Specifications

Symbols

Type BF medical electrical equipment	
Legal manufacturer of the device	
EU/EC European Authorised Representative	
Consult instructions for use	
<p>The Waste Electrical and Electronic Equipment Directive (WEEE Directive). At the end of the product lifecycle, do not throw this product into normal household garbage, but take it to a collection point for the recycling of electronic equipment</p>	
Ingress Protection Rating	IP21
Use-by date	 YYYY MM DD
Humidity, temperature and air pressure limit for storage and transport	
<p>Humidity, temperature and air pressure limit for operating conditions After any exposure to hot or cold temperatures outside the specified operating range of 10 - 40°C allow the product to re-adjust to the recommended operating temperatures to ensure continued product performance.</p>	
Indoor Use Only	
Medical device does not contain natural rubber latex	
Do not disassemble	

Your 2-year warranty

It is important to retain the retailer's receipt as proof of purchase. Staple your receipt to this back cover for future reference.

Please quote the following information if the product develops a fault. These numbers can be found on the base of the product:

Model no:

Lot no:

All Revitive devices are individually tested before leaving the factory. In the unlikely event of any device proving to be faulty within 30 days of purchase, it should be returned to the place of purchase for it to be replaced.

If the fault develops after 30 days and within 24 months of original purchase, you should contact your local distributor quoting model number and LOT number on the product, or write to your local distributor at the address shown.

You will be asked to return the product (in secure, adequate packaging) to the address shown with a copy of proof of purchase.

Subject to the exclusions set out (see Exclusions) the faulty device will then be repaired or replaced and dispatched, usually within 14 working days of receipt.

If, for any reason, this item is replaced during the 2-year guarantee period, the guarantee on the new item will be calculated from the original purchase date. Therefore, it is vital to retain your original till receipt or invoice to indicate the date of initial purchase.

To qualify for the 2-year guarantee, Revitive must have been used according to the manufacturer's instructions supplied.

Exclusions

- 1 Actegy, manufacturer of Revitive devices, shall not be liable to replace the goods under the terms of the guarantee where:
 - The fault has been caused or is attributable to accidental use, misuse, negligent use or used contrary to the manufacturer's recommendations or where the fault has been caused by power surges or damage caused in transit.
 - Revitive has been used on a voltage supply other than that stated on the product or used with a power adaptor other than the one supplied with the product.
 - Repairs have been attempted by persons other than our service staff (or authorised dealer).
 - Revitive has been used for hire purposes or non-domestic use.
 - Revitive is second hand.
- 2 Actegy are not liable to carry out any type of servicing work, under the guarantee.
- 3 Accessories such as electrode pads and bags are not covered by the guarantee.
- 4 Remote control batteries and any damage from leakage are not covered by the guarantee.
- 5 This guarantee does not confer any rights other than those expressly set out above and does not cover any claims for consequential loss or damage. This guarantee is offered as an additional benefit and does not affect your statutory rights as a consumer.

To activate your free 2-year warranty please register your device at:
support.revitive.com

REVITIVE®

Medic Coach



Actegy Ltd

1 West Point, Western Road
Bracknell, RG12 1HJ
United Kingdom
Tel: +44 (0)800 014 6233



MDSS

Schiffgraben 41
30175 Hannover, Germania.

Distributor

UK:

Actegy Ltd
1 West Point, Western Road
Bracknell, RG12 1HJ
United Kingdom
Tel: +44 (0)800 014 6233
info.uk@actegy.com



**UK
CA
0086**

**CE
2797**

Copyright © 2022 Actegy Ltd. All rights reserved. Actegy®, Revitive®, Revitive Medic Coach®, Circulation Booster®, OxyWave® and IsoRocker® are trademarks or registered trademarks of Actegy Ltd. The Actegy product is a proprietary design and is protected by applicable design laws.

Pictures used within this manual are representative only and may change.

5610_IFU03_DIGITAL_18432014 02.2022

CIRCULATION BOOSTER®

www.revitive.com